

ADV7390/ADV7391/ADV7392/ADV7393

FEATURES

- 3 high quality, 10-bit video DACs
 - 16x (216 MHz) DAC oversampling for SD
 - 8x (216 MHz) DAC oversampling for ED
 - 4x (297 MHz) DAC oversampling for HD
 - 37 mA maximum DAC output current
- Multiformat video input support
 - 4:2:2 YCrCb (SD, ED, and HD)
 - 4:4:4 RGB (SD)
- Multiformat video output support
 - Composite (CVBS) and S-Video (Y/C)
 - Component YPrPb (SD, ED, and HD)
 - Component RGB (SD, ED, and HD)
- Lead frame chip scale package (LFCSP) options
 - 32-lead, 5 mm x 5 mm LFCSP
 - 40-lead, 6 mm x 6 mm LFCSP
- Advanced power management
 - Patented content-dependent low power DAC operation
 - Automatic cable detection and DAC power-down
 - Individual DAC on/off control
 - Sleep mode with minimal power consumption
- 74.25 MHz 8-/10-/16-bit high definition input support
 - Compliant with SMPTE 274M (1080i), 296M (720p), and 240M (1035i)
- EIA/CEA-861B compliance support
- NTSC M, PAL B/D/G/H/I/M/N, PAL 60 support

- NTSC and PAL square pixel operation (24.54 MHz/29.5 MHz)
- Macrovision® Rev 7.1.L1 (SD) and Rev 1.2 (ED) compliant
- Programmable features
 - Luma and chroma filter responses
 - Vertical blanking interval (VBI)
 - Subcarrier frequency (F_{sc}) and phase
 - Luma delay
- Copy generation management system (CGMS)
- Closed captioning and wide screen signaling (WSS)
- Integrated subcarrier locking to external video source
- Complete on-chip video timing generator
- On-chip test pattern generation
- Serial MPU interface with dual I²C® and SPI® compatibility
- 2.7 V or 3.3 V analog operation
- 1.8 V digital operation
- 3.3 V I/O operation
- Temperature range: -40°C to +85°C

APPLICATIONS

- Mobile handsets
- Digital still cameras
- Portable media and DVD players
- Portable game consoles
- Digital camcorders
- Set-top box (STB)
- Automotive infotainment (ADV7393 only)

FUNCTIONAL BLOCK DIAGRAM

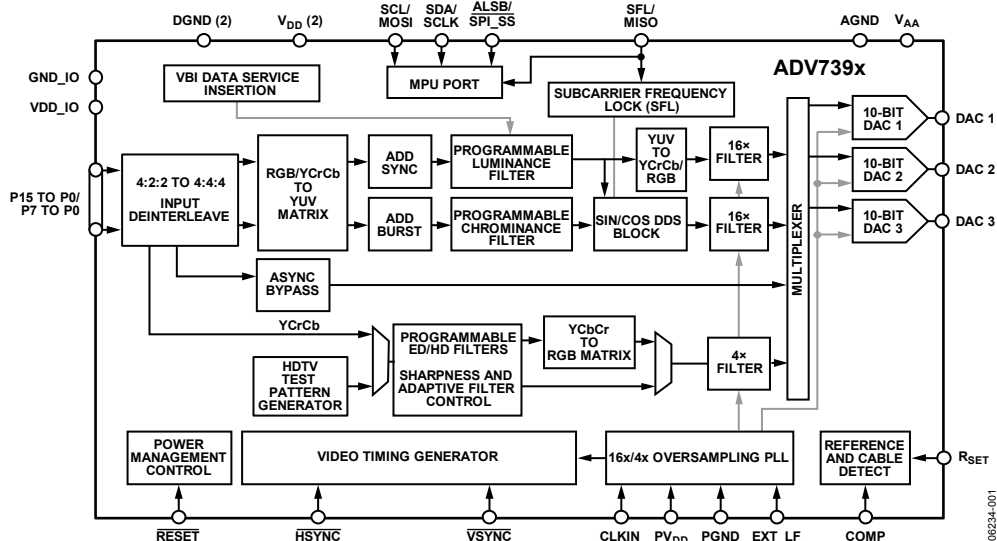

Figure 1.

Protected by U.S. Patent Numbers 5,343,196 and 5,442,355 and other intellectual property rights.
Protected by U.S. Patent Numbers 4,631,603, 4,577,216, 4,819,098, and other intellectual property rights.

Rev. 0

Information furnished by Analog Devices is believed to be accurate and reliable. However, no responsibility is assumed by Analog Devices for its use, nor for any infringements of patents or other rights of third parties that may result from its use. Specifications subject to change without notice. No license is granted by implication or otherwise under any patent or patent rights of Analog Devices. Trademarks and registered trademarks are the property of their respective owners.

One Technology Way, P.O. Box 9106, Norwood, MA 02062-9106, U.S.A.
Tel: 781.329.4700 www.analog.com
Fax: 781.461.3113 ©2006 Analog Devices, Inc. All rights reserved.

TABLE OF CONTENTS

Features	1	SD Subcarrier Frequency Lock, Subcarrier Reset, and Timing Reset	46
Applications	1	SD VCR FF/RW Sync	47
Functional Block Diagram	1	Vertical Blanking Interval	47
Revision History	3	SD Subcarrier Frequency Registers.....	47
Detailed Features	4	SD NonInterlaced Mode.....	48
General Description	4	SD Square Pixel Mode	48
Specifications.....	5	Filters.....	49
Power Supply Specifications.....	5	ED/HD Test Pattern Color Controls	50
Input Clock Specifications	5	Color Space Conversion Matrix	50
Analog Output Specifications	5	SD Luma and Color Control.....	51
Digital Input/Output Specifications.....	6	SD Hue Adjust Control.....	52
MPU Port Timing Specifications	6	SD Brightness Detect	52
Digital Timing Specifications	7	SD Brightness Control.....	52
Video Performance Specifications	8	SD Input Standard Auto Detection.....	52
Power Specifications	8	Double Buffering.....	53
Timing Diagrams.....	9	Programmable DAC Gain Control	53
Absolute Maximum Ratings.....	15	Gamma Correction	53
Thermal Resistance	15	ED/HD Sharpness Filter and Adaptive Filter Controls.....	55
ESD Caution.....	15	ED/HD Sharpness Filter and Adaptive Filter Application Examples.....	56
Pin Configurations and Function Descriptions	16	SD Digital Noise Reduction.....	57
Typical Performance Characteristics	18	SD Active Video Edge Control	59
MPU Port Description.....	23	External Horizontal and Vertical Synchronization Control.....	60
I ² C Operation.....	23	Low Power Mode.....	61
SPI Operation.....	24	Cable Detection	61
Register Map.....	25	DAC Auto Power-Down.....	61
Register Programming.....	25	Pixel and Control Port Readback.....	61
Subaddress Register (SR7 to SR0)	25	Reset Mechanisms.....	61
ADV7390/ADV7391 Input Configuration	41	Printed Circuit Board Layout and Design	62
Standard Definition.....	41	DAC Configurations.....	62
Enhanced Definition/High Definition	41	Video Output Buffer and Optional Output Filter.....	62
Enhanced Definition (At 54 MHz)	41	Printed Circuit Board (PCB) Layout	63
ADV7392/ADV7393 Input Configuration	42	Typical Application Circuit.....	65
Standard Definition.....	42	Appendix 1–Copy Generation Management System	66
Enhanced Definition/High Definition	43	SD CGMS	66
Enhanced Definition (At 54 MHz)	43	ED CGMS.....	66
Output Configuration	44	HD CGMS.....	66
Features	45	CGMS CRC Functionality	66
Output Oversampling.....	45	Appendix 2–SD Wide Screen Signaling	69
ED/HD Nonstandard Timing Mode.....	45		
ED/HD Timing Reset	46		

Appendix 3–SD Closed Captioning.....	70	SD/ED/HD RGB Output Levels.....	80
Appendix 4–Internal Test Pattern Generation.....	71	SD Output Plots	81
SD Test Patterns.....	71	Appendix 8–Video Standards.....	82
ED/HD Test Patterns	71	Appendix 9–Configuration Scripts.....	84
Appendix 5–SD Timing.....	72	Standard Definition	84
Appendix 6–HD Timing	77	Enhanced Definition	90
Appendix 7–Video Output Levels.....	78	High Definition	92
SD YPrPb Output Levels—SMPTE/EBU N10	78	Outline Dimensions.....	95
ED/HD YPrPb Output Levels	79	Ordering Guide	96

REVISION HISTORY

10/06—Revision 0: Initial Version

ADV7390/ADV7391/ADV7392/ADV7393

DETAILED FEATURES

High definition (HD) programmable features

(720p/1080i/1035i)

4× oversampling (297 MHz)

Internal test pattern generator

Color and black bar, hatch, flat field/frame

Fully programmable YCrCb to RGB matrix

Gamma correction

Programmable adaptive filter control

Programmable sharpness filter control

CGMS (720p/1080i) and CGMS Type B (720p/1080i)

Dual data rate (DDR) input support

EIA/CEA-861B compliance support

Enhanced definition (ED) programmable features

(525p/625p)

8× oversampling (216 MHz output)

Internal test pattern generator

Color and black bar, hatch, flat field/frame

Individual Y and PrPb output delay

Gamma correction

Programmable adaptive filter control

Fully programmable YCrCb to RGB matrix

Undershoot limiter

Macrovision Rev 1.2 (525p/625p)

CGMS (525p/625p) and CGMS Type B (525p)

Dual data rate (DDR) input support

EIA/CEA-861B compliance support

Standard definition (SD) programmable features

16× oversampling (216 MHz)

Internal test pattern generator

Color and black bar

Controlled edge rates for start and end of active video

Individual Y and PrPb output delay

Undershoot limiter

Gamma correction

Digital noise reduction (DNR)

Multiple chroma and luma filters

Luma-SSAF™ filter with programmable gain/attenuation

PrPb SSAF™

Separate pedestal control on component and composite/S-Video output

VCR FF/RW sync mode

Macrovision Rev 7.1.L1

Copy generation management system (CGMS)

Wide screen signaling (WSS)

Closed captioning

EIA/CEA-861B compliance support

GENERAL DESCRIPTION

The ADV7390/ADV7391/ADV7392/ADV7393 are a family of high speed, digital-to-analog video encoders on single monolithic chips. Three 2.7 V/3.3 V 10-bit video DACs provide support for composite (CVBS), S-Video (YC), or component

(YPrPb/RGB) analog outputs in either standard-definition (SD) or high-definition (HD) video formats.

Optimized for low power operation, occupying a minimal footprint and requiring few external components, these encoders are ideally suited to portable and power sensitive applications requiring TV-Out functionality. Cable detection and DAC auto power-down features ensure that power consumption is kept to a minimum.

The ADV7390/ADV7391 have an 8-bit video input port that supports SD video formats over a SDR interface and HD video formats over a DDR interface.

The ADV7392/ADV7393 have a 16-bit video input port that can be configured in a variety of ways. SD RGB input is supported.

All members of the family support embedded EAV/SAV timing codes, external video synchronization signals and the I²C and SPI communication protocols.

Table 1 lists the video standards directly supported by the ADV739x family.

Table 1. Standards Directly Supported by the ADV739x¹

Resolution	I/P ²	Frame Rate (Hz)	Clock Input (MHz)	Standard
720 × 240	P	59.94	27	
720 × 288	P	50	27	
720 × 480	I	29.97	27	ITU-R BT.601/656
720 × 576	I	25	27	ITU-R BT.601/656
720 × 480	I	29.97	24.54	NTSC Square Pixel
720 × 576	I	25	29.5	PAL Square Pixel
720 × 483	P	59.94	27	SMPTE 293M
720 × 483	P	59.94	27	BTA T-1004
720 × 483	P	59.94	27	ITU-R BT.1358
720 × 576	P	50	27	ITU-R BT.1358
720 × 483	P	59.94	27	ITU-R BT.1362
720 × 576	P	50	27	ITU-R BT.1362
1920 × 1035	I	30	74.25	SMPTE 240M
1920 × 1035	I	29.97	74.1758	SMPTE 240M
1280 × 720	P	60, 50, 30, 25, 24	74.25	SMPTE 296M
1280 × 720	P	23.97, 59.94, 29.97	74.1758	SMPTE 296M
1920 × 1080	I	30, 25	74.25	SMPTE 274M
1920 × 1080	I	29.97	74.1758	SMPTE 274M
1920 × 1080	P	30, 25, 24	74.25	SMPTE 274M
1920 × 1080	P	23.98, 29.97	74.1758	SMPTE 274M
1920 × 1080	P	24	74.25	ITU-R BT.709-5

¹ Other standards are supported in the ED/HD nonstandard timing mode.

² I = interlaced, P = progressive.

SPECIFICATIONS

POWER SUPPLY SPECIFICATIONS

All specifications T_{MIN} to T_{MAX} ($-40^{\circ}C$ to $+85^{\circ}C$), unless otherwise noted.

Table 2.

Parameter	Conditions	Min	Typ	Max	Unit
SUPPLY VOLTAGES					
V_{DD}		1.71	1.8	1.89	V
V_{DD_IO}		2.97	3.3	3.63	V
PV_{DD}		1.71	1.8	1.89	V
V_{AA}		2.6	3.3	3.465	V
POWER SUPPLY REJECTION RATIO			0.002		%/%

INPUT CLOCK SPECIFICATIONS

$V_{DD} = 1.71$ V to 1.89 V, $PV_{DD} = 1.71$ V to 1.89 V, $V_{AA} = 2.6$ V to 3.465 V, $V_{DD_IO} = 2.97$ V to 3.63 V.

All specifications T_{MIN} to T_{MAX} ($-40^{\circ}C$ to $+85^{\circ}C$), unless otherwise noted.

Table 3.

Parameter	Conditions ¹	Min	Typ	Max	Unit
f_{CLKIN}	SD/ED		27		MHz
	ED (at 54 MHz)		54		MHz
	HD		74.25		MHz
CLKIN High Time, t_9		40			% of one clock cycle
CLKIN Low Time, t_{10}		40			% of one clock cycle
CLKIN Peak-to-Peak Jitter Tolerance			2		$\pm ns$

¹ SD = standard definition, ED = enhanced definition (525p/625p), HD = high definition.

ANALOG OUTPUT SPECIFICATIONS

$V_{DD} = 1.71$ V to 1.89 V, $PV_{DD} = 1.71$ V to 1.89 V, $V_{AA} = 2.6$ V to 3.465 V, $V_{DD_IO} = 2.97$ V to 3.63 V.

All specifications T_{MIN} to T_{MAX} ($-40^{\circ}C$ to $+85^{\circ}C$), unless otherwise noted.

Table 4.

Parameter	Conditions	Min	Typ	Max	Unit
Full-Drive Output Current	$R_{SET} = 510 \Omega$, $R_L = 37.5 \Omega$	33	34.6	37	mA
Low Drive Output Current	$R_{SET} = 4.12 k\Omega$, $R_L = 300 \Omega$		4.3		mA
DAC-to-DAC Matching	DAC 1, DAC 2, DAC 3		2.0		%
Output Compliance, V_{OC}		0		1.4	V
Output Capacitance, C_{OUT}			10		pF
Analog Output Delay ¹			6		ns
DAC Analog Output Skew	DAC 1, DAC 2, DAC 3		1		ns

¹ Output delay measured from the 50% point of the rising edge of the input clock to the 50% point of the DAC output full-scale transition.

ADV7390/ADV7391/ADV7392/ADV7393

DIGITAL INPUT/OUTPUT SPECIFICATIONS

$V_{DD} = 1.71 \text{ V to } 1.89 \text{ V}$, $PV_{DD} = 1.71 \text{ V to } 1.89 \text{ V}$, $V_{AA} = 2.6 \text{ V to } 3.465 \text{ V}$, $V_{DD_IO} = 2.97 \text{ V to } 3.63 \text{ V}$.

All specifications T_{MIN} to T_{MAX} (-40°C to $+85^{\circ}\text{C}$), unless otherwise noted.

Table 5.

Parameter	Conditions	Min	Typ	Max	Unit
Input High Voltage, V_{IH}		2.0			V
Input Low Voltage, V_{IL}				0.8	V
Input Leakage Current, I_{IN}	$V_{IN} = V_{DD_IO}$			± 10	μA
Input Capacitance, C_{IN}			4		pF
Output High Voltage, V_{OH}	$I_{SOURCE} = 400 \mu\text{A}$	2.4			V
Output Low Voltage, V_{OL}	$I_{SINK} = 3.2 \text{ mA}$			0.4	V
Three-State Leakage Current	$V_{IN} = 0.4 \text{ V, } 2.4 \text{ V}$			± 1	μA
Three-State Output Capacitance			4		pF

MPU PORT TIMING SPECIFICATIONS

$V_{DD} = 1.71 \text{ V to } 1.89 \text{ V}$, $PV_{DD} = 1.71 \text{ V to } 1.89 \text{ V}$, $V_{AA} = 2.6 \text{ V to } 3.465 \text{ V}$, $V_{DD_IO} = 2.97 \text{ V to } 3.63 \text{ V}$.

All specifications T_{MIN} to T_{MAX} (-40°C to $+85^{\circ}\text{C}$), unless otherwise noted.

Table 6.

Parameter	Conditions	Min	Typ	Max	Unit
MPU PORT, I ² C MODE ¹	See Figure 15				
SCL Frequency		0		400	kHz
SCL High Pulse Width, t_1		0.6			μs
SCL Low Pulse Width, t_2		1.3			μs
Hold Time (Start Condition), t_3		0.6			μs
Setup Time (Start Condition), t_4		0.6			μs
Data Setup Time, t_5		100			ns
SDA, SCL Rise Time, t_6				300	ns
SDA, SCL Fall Time, t_7				300	ns
Setup Time (Stop Condition), t_8		0.6			μs
MPU PORT, SPI MODE ¹	See Figure 16				
SCLK Frequency		0		10	MHz
$\overline{\text{SPI_SS}}$ to SCLK Setup Time, t_1		20			ns
SCLK High Pulse Width, t_2		50			ns
SCLK Low Pulse Width, t_3		50			ns
Data Access Time after SCLK Falling Edge, t_4				35	ns
Data Setup Time prior to SCLK Rising Edge, t_5		20			ns
Data Hold Time after SCLK Rising Edge, t_6		0			ns
$\overline{\text{SPI_SS}}$ to SCLK Hold Time, t_7		0			ns
$\overline{\text{SPI_SS}}$ to MISO High Impedance, t_8				40	ns

¹ Guaranteed by characterization.

DIGITAL TIMING SPECIFICATIONS

$V_{DD} = 1.71\text{ V to }1.89\text{ V}$, $PV_{DD} = 1.71\text{ V to }1.89\text{ V}$, $V_{AA} = 2.6\text{ V to }3.465\text{ V}$, $V_{DD_{IO}} = 2.97\text{ V to }3.63\text{ V}$.

All specifications T_{MIN} to T_{MAX} (-40°C to $+85^{\circ}\text{C}$), unless otherwise noted.

Table 7.

Parameter	Conditions ¹	Min	Typ	Max	Unit
VIDEO DATA AND VIDEO CONTROL PORT^{2, 3}					
Data Input Setup Time, t_{11}^4	SD	2.1			ns
	ED/HD-SDR	2.3			ns
	ED/HD-DDR	2.3			ns
	ED (at 54 MHz)	1.7			ns
Data Input Hold Time, t_{12}^4	SD	1.0			ns
	ED/HD-SDR	1.1			ns
	ED/HD-DDR	1.1			ns
	ED (at 54 MHz)	1.0			ns
Control Input Setup Time, t_{11}^4	SD	2.1			ns
	ED/HD-SDR or ED/HD-DDR	2.3			ns
	ED (at 54 MHz)	1.7			ns
Control Input Hold Time, t_{12}^4	SD	1.0			ns
	ED/HD-SDR or ED/HD-DDR	1.1			ns
	ED (at 54 MHz)	1.0			ns
Control Output Access Time, t_{13}^4	SD			12	ns
	ED/HD-SDR, ED/HD-DDR, or ED (at 54 MHz)			10	ns
Control Output Hold Time, t_{14}^4	SD	4.0			ns
	ED/HD-SDR, ED/HD-DDR, or ED (at 54 MHz)	3.5			ns
PIPELINE DELAY⁵					
SD ¹					
CVBS/YC Outputs (2×)	SD oversampling disabled		68		clock cycles
CVBS/YC Outputs (8×)	SD oversampling disabled		79		clock cycles
CVBS/YC Outputs (16×)	SD oversampling enabled		67		clock cycles
Component Outputs (2×)	SD oversampling disabled		78		clock cycles
Component Outputs (8×)	SD oversampling disabled		69		clock cycles
Component Outputs (16×)	SD oversampling enabled		84		clock cycles
ED ¹					
Component Outputs (1×)	ED oversampling disabled		41		clock cycles
Component Outputs (4×)	ED oversampling disabled		49		clock cycles
Component Outputs (8×)	ED oversampling enabled		46		clock cycles
HD ¹					
Component Outputs (1×)	HD oversampling disabled		40		clock cycles
Component Outputs (2×)	HD oversampling disabled		42		clock cycles
Component Outputs (4×)	HD oversampling enabled		44		clock cycles
RESET CONTROL					
RESET Low Time		100			ns

¹ SD = standard definition, ED = enhanced definition (525p/625p), HD = high definition, SDR = single data rate, DDR = dual data rate.

² Video Data: P[15:0] for ADV7392/ADV7393 or P[7:0] for ADV7390/ADV7391.

³ Video Control: HSYNC and VSYNC.

⁴ Guaranteed by characterization.

⁵ Guaranteed by design.

ADV7390/ADV7391/ADV7392/ADV7393

VIDEO PERFORMANCE SPECIFICATIONS

Table 8.

Parameter	Conditions	Min	Typ	Max	Unit
STATIC PERFORMANCE					
Resolution			10		Bits
Integral Nonlinearity (INL) ¹	$R_{SET} = 510 \Omega$, $R_L = 37.5 \Omega$		0.5		LSBs
Differential Nonlinearity (DNL) ^{1, 2}	$R_{SET} = 510 \Omega$, $R_L = 37.5 \Omega$		0.5		LSBs
STANDARD DEFINITION (SD) MODE					
Luminance Nonlinearity			0.5		±%
Differential Gain	NTSC		0.5		%
Differential Phase	NTSC		0.6		Degrees
Signal-to-Noise Ratio (SNR) ³	Luma ramp		58		dB
	Flat field full bandwidth		75		dB
ENHANCED DEFINITION (ED) MODE					
Luma Bandwidth			12.5		MHz
Chroma Bandwidth			5.8		MHz
HIGH DEFINITION (HD) MODE					
Luma Bandwidth			30.0		MHz
Chroma Bandwidth			13.75		MHz

¹ Measured on DAC 1, DAC 2, and DAC 3.

² Differential nonlinearity (DNL) measures the deviation of the actual DAC output voltage step from the ideal. For +ve DNL, the actual step value lies above the ideal step value. For -ve DNL, the actual step value lies below the ideal step value.

³ Measured on the ADV7392/ADV7393 operating in 10-bit input mode.

POWER SPECIFICATIONS

Table 9.

Parameter	Conditions	Min	Typ	Max	Unit
NORMAL POWER MODE ^{1, 2}					
I_{DD} ³	SD (16× oversampling enabled), CVBS		33		mA
	SD (16× oversampling enabled), YPrPb		68		mA
	ED (8× oversampling enabled) ⁴		59		mA
	HD (4× oversampling enabled) ⁴		81		mA
I_{DD_IO}			1		mA
I_{AA} ⁵	1 DAC enabled		50		mA
	All DACs enabled		122		mA
I_{PLL}			4		mA
SLEEP MODE					
I_{DD}			5		μA
I_{AA}			0.3		μA
I_{DD_IO}			0.2		μA
I_{PLL}			0.1		μA

¹ $R_{SET} = 510 \Omega$ (all DACs operating in full-drive mode).

² 75% color bar test pattern applied to pixel data pins.

³ I_{DD} is the continuous current required to drive the digital core.

⁴ Applicable to both single data rate (SDR) and dual data rate (DDR) input modes.

⁵ I_{AA} is the total current required to supply all DACs.

TIMING DIAGRAMS

The following abbreviations are used in Figure 2 to Figure 9.

- t_9 = Clock high time
- t_{10} = Clock low time
- t_{11} = Data setup time
- t_{12} = Data hold time
- t_{13} = Control output access time
- t_{14} = Control output hold time

In addition, refer to Table 30 for the ADV7390/ADV7391 input configuration and Table 31 for the ADV7392/ADV7393 input configuration.

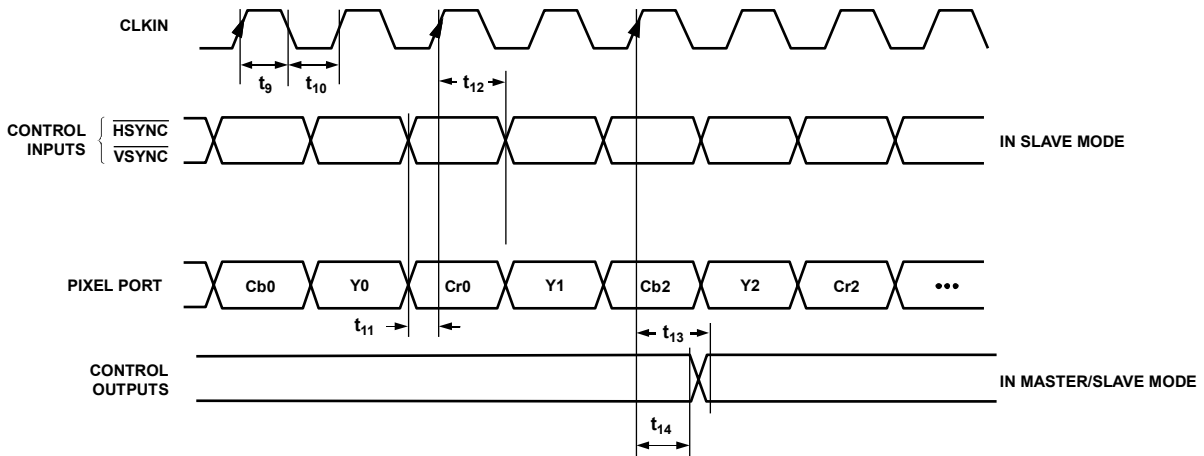

Figure 2. SD Input, 8-/10-Bit 4:2:2 YCrCb (Input Mode 000)

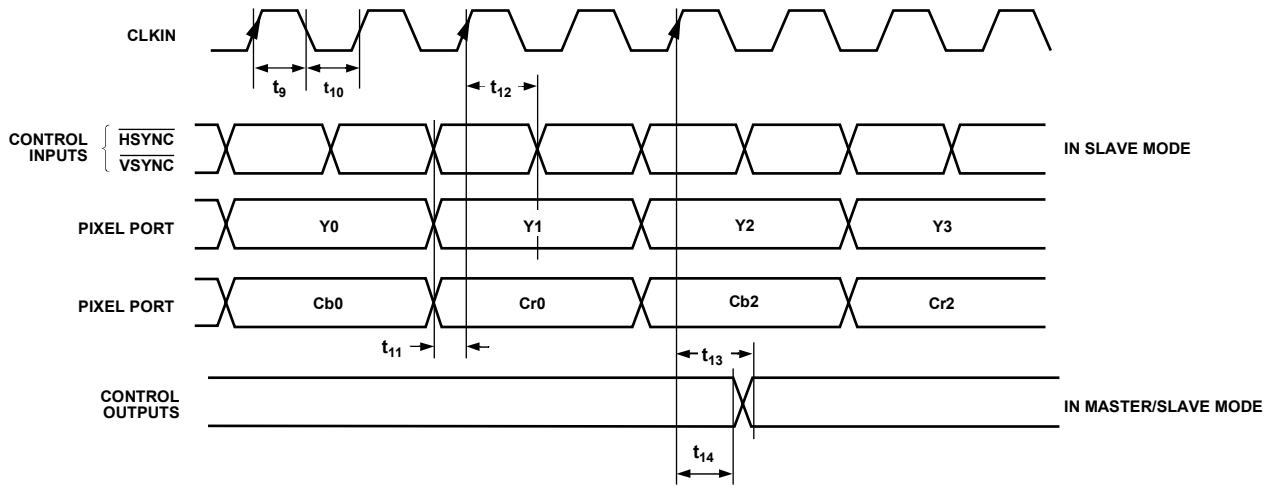

Figure 3. SD Input, 16-Bit 4:2:2 YCrCb (Input Mode 000)

ADV7390/ADV7391/ADV7392/ADV7393

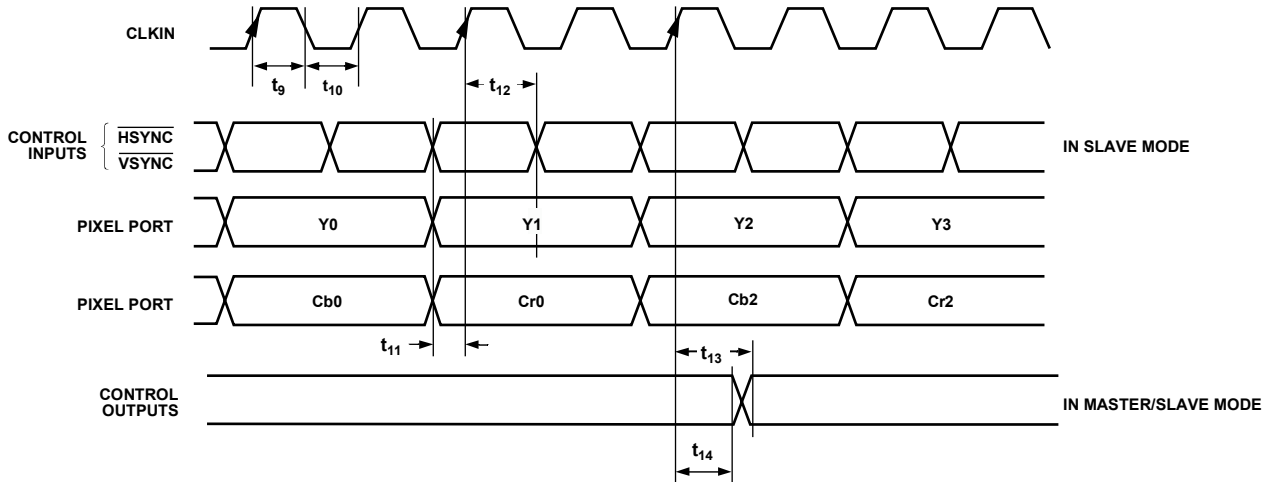

Figure 4. SD Input, 16-Bit 4:4:4 RGB (Input Mode 000)

06234-003

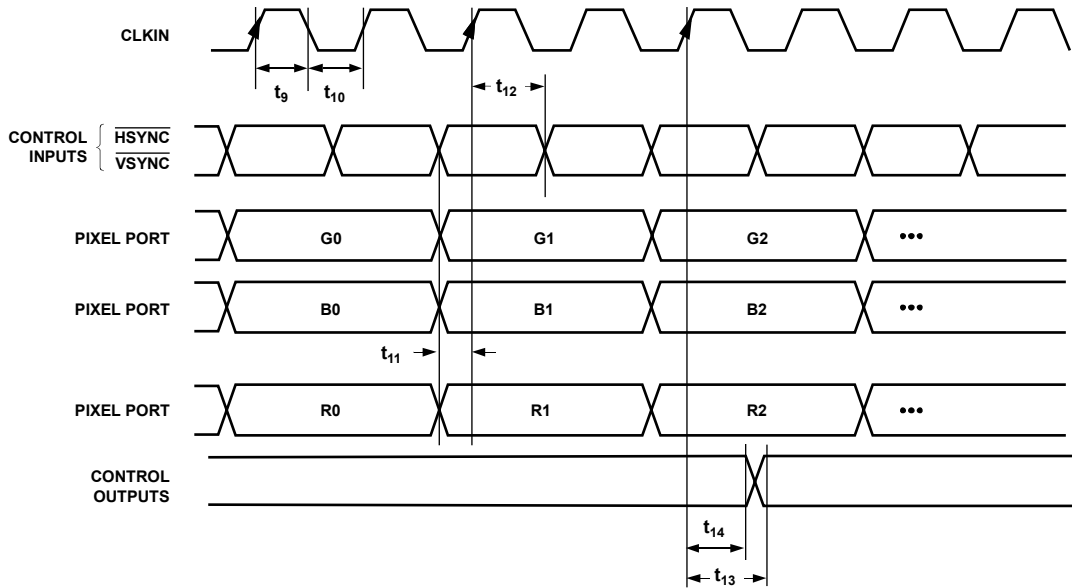
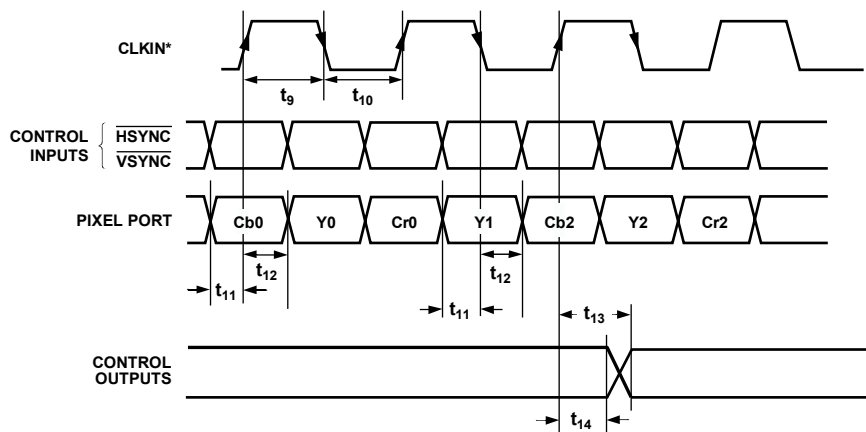

Figure 5. ED/HD-SDR Input, 16-Bit 4:2:2 YCrCb (Input Mode 001)

06234-004



*LUMA/CHROMA CLOCK RELATIONSHIP CAN BE INVERTED USING SUBADDRESS 0x01, BITS 1 AND 2.

Figure 6. ED/HD-DDR Input, 8-/10-Bit 4:2:2 YCrCb (HSYNC/VSYNC), Input Mode 010

06234-006

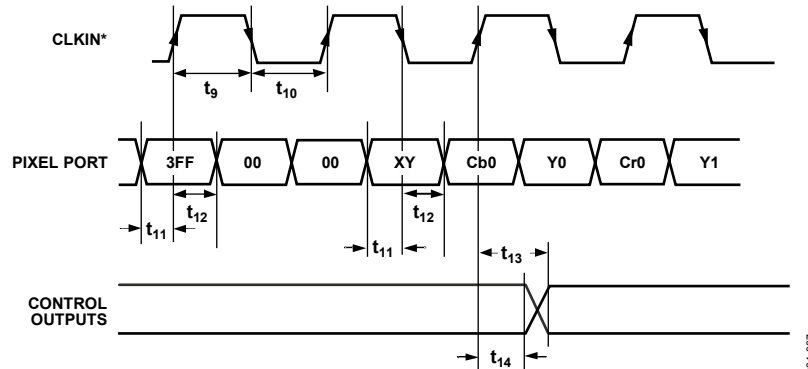

*LUMA/CHROMA CLOCK RELATIONSHIP CAN BE INVERTED USING SUBADDRESS 0x01, BITS 1 AND 2.

Figure 7. ED/HD-DDR Input, 8-/10-Bit 4:2:2 YCrCb (EAV/SAV), Input Mode 010

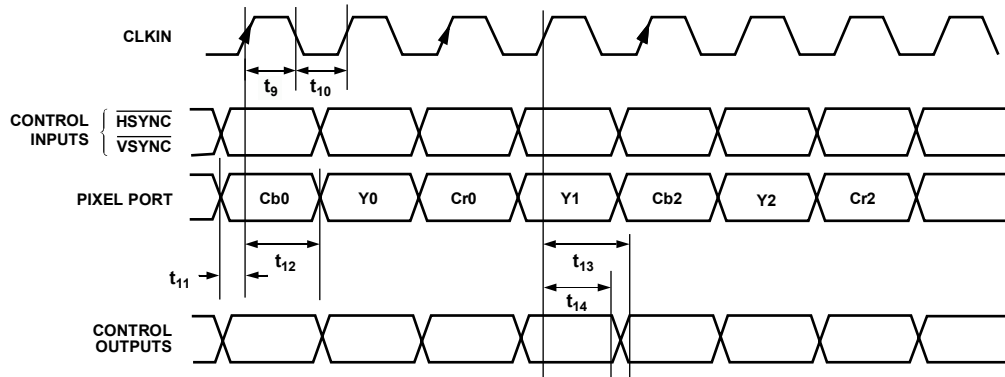

Figure 8. ED (at 54 MHz) Input, 8-/10-Bit 4:2:2 YCrCb (HSYNC/VSYNC), Input Mode 111

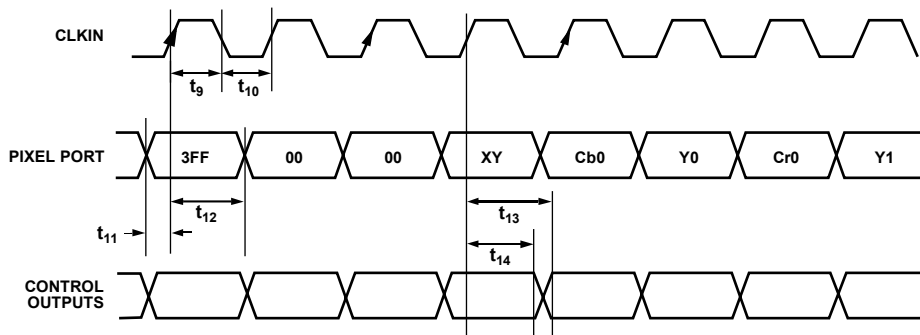
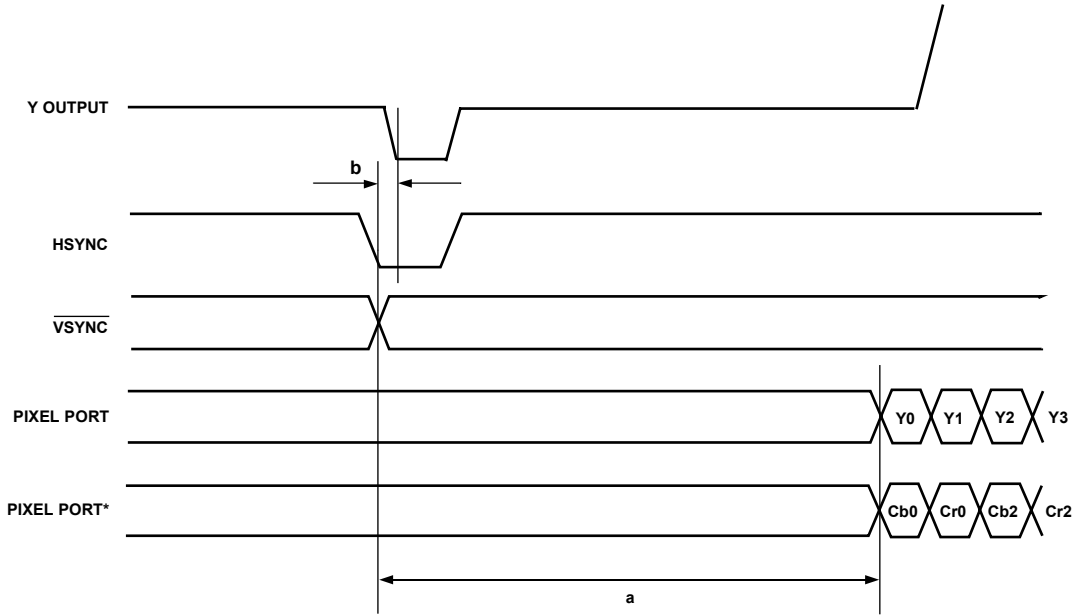

Figure 9. ED (at 54 MHz) Input, 8-/10-Bit 4:2:2 YCrCb (EAV/SAV), Input Mode 111

ADV7390/ADV7391/ADV7392/ADV7393



a = AS PER RELEVANT STANDARD.

b = PIPELINE DELAY. PLEASE REFER TO RELEVANT PIPELINE DELAY. THIS CAN BE FOUND IN THE DIGITAL TIMING SPECIFICATION SECTION OF THE DATA SHEET.

A FALLING EDGE OF $\overline{\text{HSYNC}}$ INTO THE ENCODER GENERATES A SYNC FALLING EDGE ON THE OUTPUT AFTER A TIME EQUAL TO THE PIPELINE DELAY.

Figure 10. ED-SDR, 16-Bit 4:2:2 YCrCb ($\overline{\text{HSYNC}}/\overline{\text{VSYNC}}$) Input Timing Diagram

06234-010

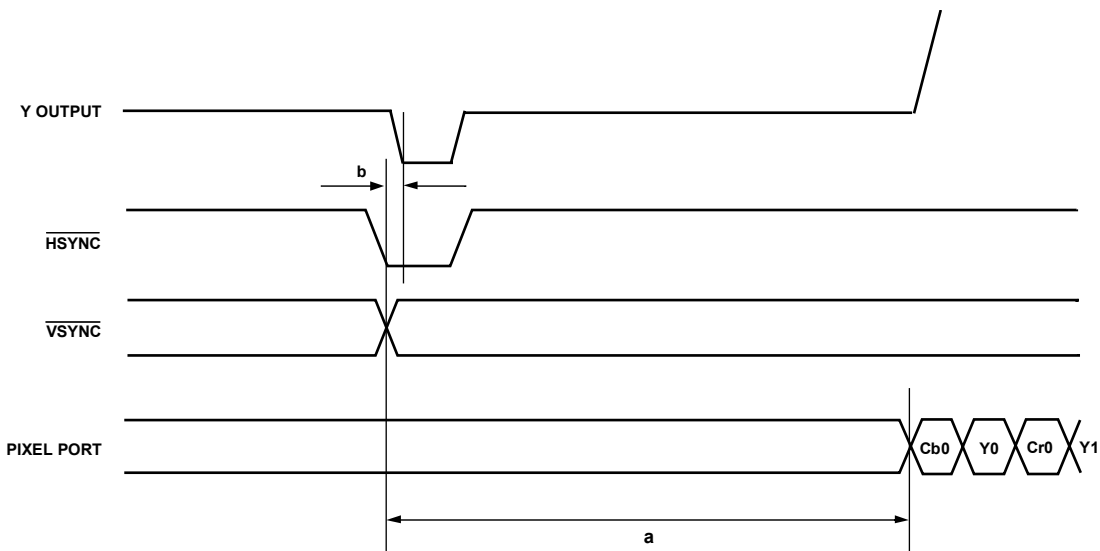

a(MIN) = 244 CLOCK CYCLES FOR 525p.
a(MIN) = 264 CLOCK CYCLES FOR 625p.

b = PIPELINE DELAY. PLEASE REFER TO RELEVANT PIPELINE DELAY. THIS CAN BE FOUND IN THE DIGITAL TIMING SPECIFICATION SECTION OF THE DATA SHEET.

A FALLING EDGE OF $\overline{\text{HSYNC}}$ INTO THE ENCODER GENERATES A SYNC FALLING EDGE ON THE OUTPUT AFTER A TIME EQUAL TO THE PIPELINE DELAY.

Figure 11. ED-DDR, 8-/10-Bit 4:2:2 YCrCb ($\overline{\text{HSYNC}}/\overline{\text{VSYNC}}$) Input Timing Diagram

06234-011

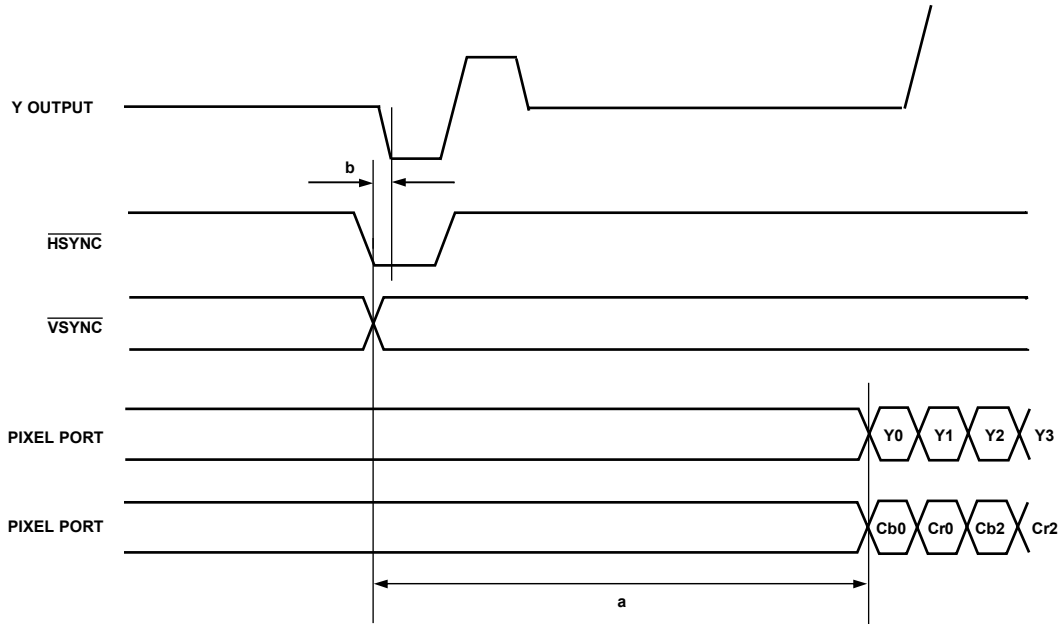

a = AS PER RELEVANT STANDARD.

b = PIPELINE DELAY. PLEASE REFER TO RELEVANT PIPELINE DELAY. THIS CAN BE FOUND IN THE DIGITAL TIMING SPECIFICATION SECTION OF THE DATA SHEET.

A FALLING EDGE OF HSYNC INTO THE ENCODER GENERATES A FALLING EDGE OF TRI-LEVEL SYNC ON THE OUTPUT AFTER A TIME EQUAL TO THE PIPELINE DELAY.

Figure 12. HD-SDR, 16-Bit 4:2:2 YCrCb (HSYNC/VSYNC) Input Timing Diagram

06234-012

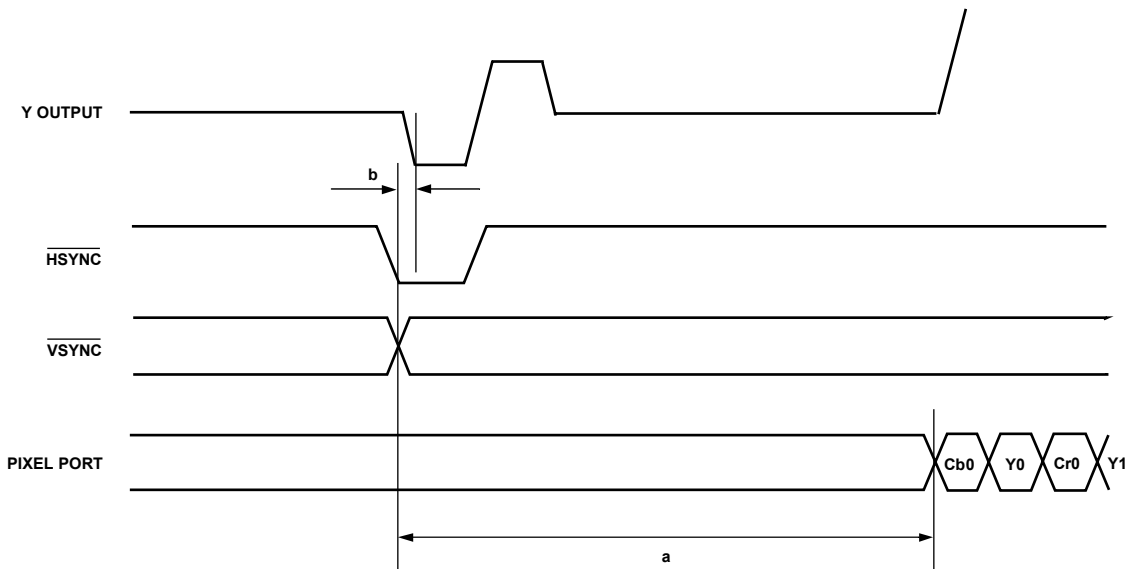

a = AS PER RELEVANT STANDARD.

b = PIPELINE DELAY. PLEASE REFER TO RELEVANT PIPELINE DELAY. THIS CAN BE FOUND IN THE DIGITAL TIMING SPECIFICATION SECTION OF THE DATA SHEET.

A FALLING EDGE OF HSYNC INTO THE ENCODER GENERATES A FALLING EDGE OF TRI-LEVEL SYNC ON THE OUTPUT AFTER A TIME EQUAL TO THE PIPELINE DELAY.

Figure 13. HD-DDR, 8-/10-Bit 4:2:2 YCrCb (HSYNC/VSYNC) Input Timing Diagram

06234-013

ADV7390/ADV7391/ADV7392/ADV7393

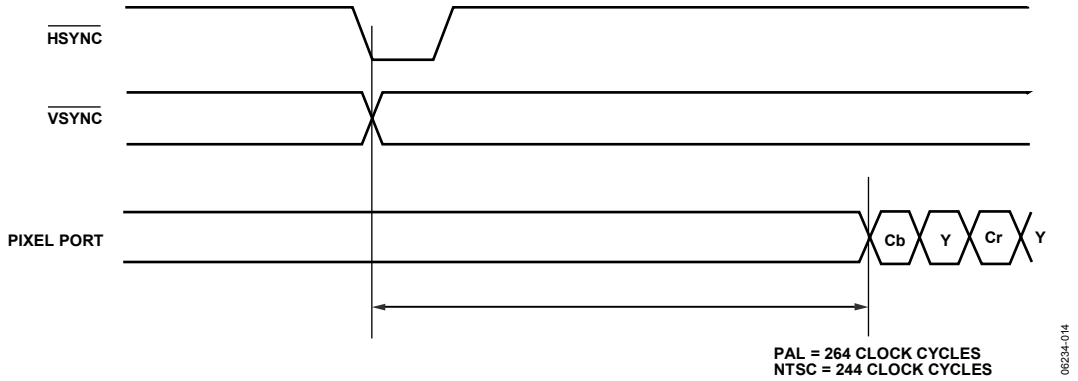

Figure 14. SD Input Timing Diagram (Timing Mode 1)

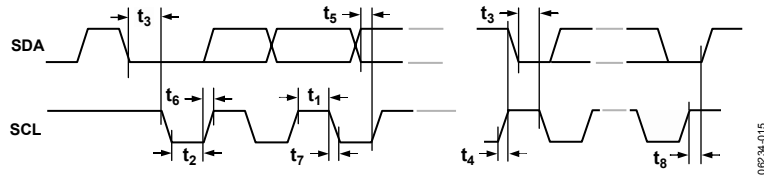

Figure 15. MPU Port Timing Diagram (I²C Mode)

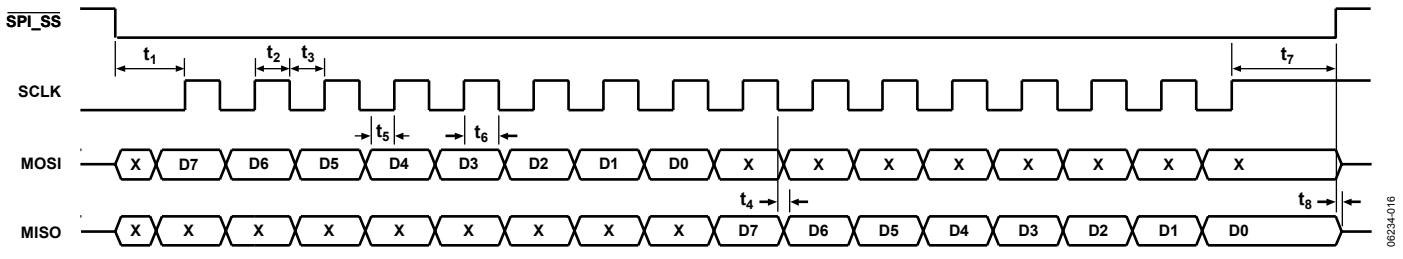

Figure 16. MPU Port Timing Diagram (SPI Mode)

ABSOLUTE MAXIMUM RATINGS

Table 10.

Parameter ¹	Rating
V _{AA} to AGND	−0.3 V to +3.9 V
V _{DD} to DGND	−0.3 V to +2.3 V
PV _{DD} to PGND	−0.3 V to +2.3 V
V _{DD_IO} to GND_IO	−0.3 V to +3.9 V
V _{AA} to V _{DD}	−0.3 V to +2.2 V
V _{DD} to PV _{DD}	−0.3 V to +0.3 V
V _{DD_IO} to V _{DD}	−0.3 V to +2.2 V
AGND to DGND	−0.3 V to +0.3 V
AGND to PGND	−0.3 V to +0.3 V
AGND to GND_IO	−0.3 V to +0.3 V
DGND to PGND	−0.3 V to +0.3 V
DGND to GND_IO	−0.3 V to +0.3 V
PGND to GND_IO	−0.3 V to +0.3 V
Digital Input Voltage to GND_IO	−0.3 V to V _{DD_IO} + 0.3 V
Analog Outputs to AGND	−0.3 V to V _{AA}
Storage Temperature Range (t _s)	−60°C to +100°C
Junction Temperature (t _j)	150°C
Lead Temperature (Soldering, 10 sec)	260°C

¹ Analog output short circuit to any power supply or common can be of an indefinite duration.

Stresses above those listed under Absolute Maximum Ratings may cause permanent damage to the device. This is a stress rating only; functional operation of the device at these or any other conditions above those indicated in the operational section of this specification is not implied. Exposure to absolute maximum rating conditions for extended periods may affect device reliability.

THERMAL RESISTANCE

θ_{JA} is specified for the worst-case conditions, that is, a device soldered in a circuit board for surface-mount packages.

Table 11. Thermal Resistance¹

Package Type	θ_{JA} ²	θ_{JC}	Unit
32-Lead LFCSP	27	32	°C/W
40-Lead LFCSP	26	32	°C/W

¹ Values are based on a JEDEC 4 layer test board.

² With the exposed metal paddle on the underside of the LFCSP soldered to the PCB ground.

The ADV739x is a Pb-free product. The lead finish is 100% pure Sn electroplate. The device is RoHS compliant, suitable for Pb-free applications up to 255°C (±5°C) IR reflow (JEDEC STD-20).

The ADV739x is backward-compatible with conventional SnPb soldering processes. The electroplated Sn coating can be soldered with SnPb solder pastes at conventional reflow temperatures of 220°C to 235°C.

ESD CAUTION



ESD (electrostatic discharge) sensitive device. Charged devices and circuit boards can discharge without detection. Although this product features patented or proprietary protection circuitry, damage may occur on devices subjected to high energy ESD. Therefore, proper ESD precautions should be taken to avoid performance degradation or loss of functionality.

ADV7390/ADV7391/ADV7392/ADV7393

PIN CONFIGURATIONS AND FUNCTION DESCRIPTIONS

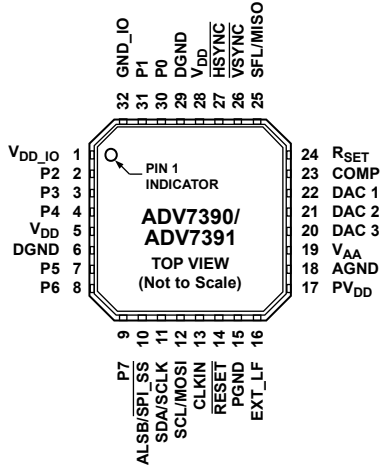

Figure 17. ADV7390/ADV7391 Pin Configuration

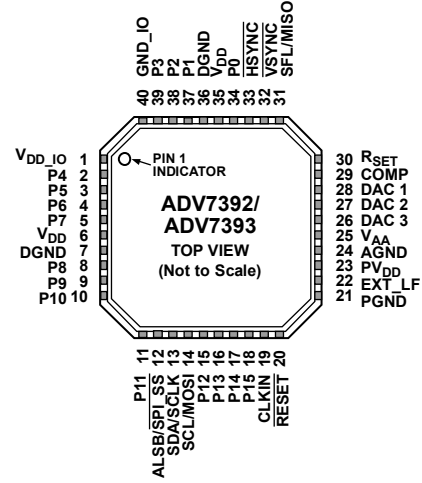

Figure 18. ADV7392/ADV7393 Pin Configuration

Table 12. Pin Function Descriptions

Pin Number		Mnemonic	Input/Output	Description
ADV7390/91	ADV7392/93			
9 to 7, 4 to 2, 31, 30		P7 to P0	I	8-Bit Pixel Port (P7 to P0). P0 is the LSB. Refer to Table 30 for input modes (ADV7390/ADV7391).
	18 to 15, 11 to 8, 5 to 2, 39 to 37, 34	P15 to P0	I	16-Bit Pixel Port (P15 to P0). P0 is the LSB. Refer to Table 31 for input modes (ADV7392/ADV7393).
13	19	CLKIN	I	Pixel Clock Input for HD (74.25 MHz), ED ¹ (27 MHz or 54 MHz), or SD (27 MHz).
27	33	HSYNC	I/O	Horizontal Synchronization Signal. This pin can also be configured to output an SD, ED, or HD horizontal synchronization signal. See the External Horizontal and Vertical Synchronization Control section.
26	32	VSYNC	I/O	Vertical Synchronization Signal. This pin can also be configured to output an SD, ED, or HD vertical synchronization signal. See the External Horizontal and Vertical Synchronization Control section.
25	31	SFL/MISO	I/O	Multifunctional Pin: Subcarrier Frequency Lock (SFL) Input/SPI Data Output (MISO). The SFL input is used to drive the color subcarrier DDS system, timing reset, or subcarrier reset.
24	30	RSET	I	Controls the amplitudes of the DAC 1, DAC 2, and DAC 3 outputs. For full-drive operation (for example, into a 37.5 Ω load), a 510 Ω resistor must be connected from RSET to AGND. For low drive operation (for example, into a 300 Ω load), a 4.12 kΩ resistor must be connected from RSET to AGND.
23	29	COMP	O	Compensation Pin. Connect a 2.2 nF capacitor from COMP to VAA.
22, 21, 20	28, 27, 26	DAC 1, DAC 2, DAC 3	O	DAC Outputs. Full-drive and low-drive capable DACs.
12	14	SCL/MOSI	I	Multifunctional Pin: I ² C Clock Input/SPI Data Input.
11	13	SDA/SCLK	I/O	Multifunctional Pin: I ² C Data Input/Output. Also, SPI clock input.
10	12	ALSB/SPI_SS	I	Multifunctional Pin: ALSB sets up the LSB ² of the MPU I ² C address/SPI slave select (SPI_SS).
14	20	RESET	I	Resets the on-chip timing generator and sets the ADV739x into its default mode.
19	25	VAA	P	Analog Power Supply (3.3 V).
5, 28	6, 35	VDD	P	Digital Power Supply (1.8 V). For dual-supply configurations, VDD can be connected to other 1.8 V supplies through a ferrite bead or suitable filtering.
1	1	VDD_IO	P	Input/Output Digital Power Supply (3.3 V).
17	23	PVDD	P	PLL Power Supply (1.8 V). For dual-supply configurations, PVDD can be connected to other 1.8 V supplies through a ferrite bead or suitable filtering.

ADV7390/ADV7391/ADV7392/ADV7393

Pin Number		Mnemonic	Input/ Output	Description
ADV7390/91	ADV7392/93			
16	22	EXT_LF	I	External Loop Filter for the Internal PLL.
15	21	PGND	G	PLL Ground Pin.
18	24	AGND	G	Analog Ground Pin.
6, 29	7, 36	DGND	G	Digital Ground Pin.
32	40	GND_IO	G	Input/Output Supply Ground Pin.

¹ ED = enhanced definition = 525p and 625p.

² LSB = least significant bit. In the ADV7390, setting the LSB to 0 sets the I²C address to 0xD4. Setting it to 1 sets the I²C address to 0xD6.
In the ADV7391, setting the LSB to 0 sets the I²C address to 0x54. Setting it to 1 sets the I²C address to 0x56.

TYPICAL PERFORMANCE CHARACTERISTICS

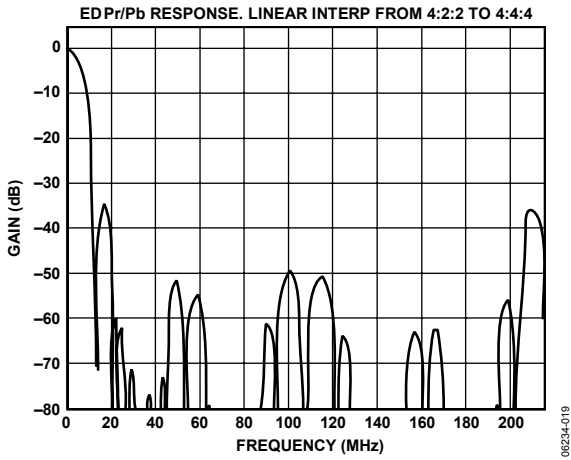

Figure 19. ED 8× Oversampling, PrPb Filter (Linear) Response

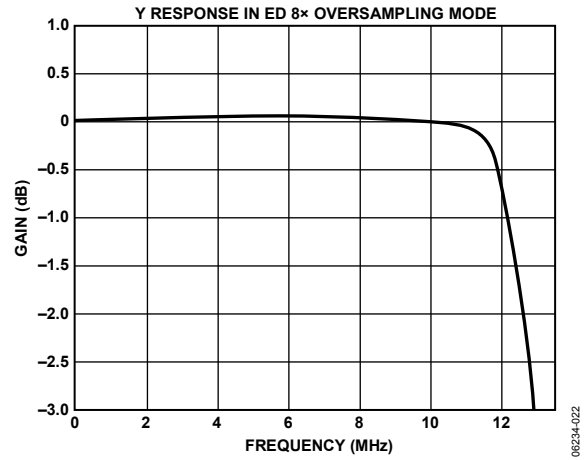

Figure 22. ED 8× Oversampling, Y Filter Response (Focus on Pass Band)

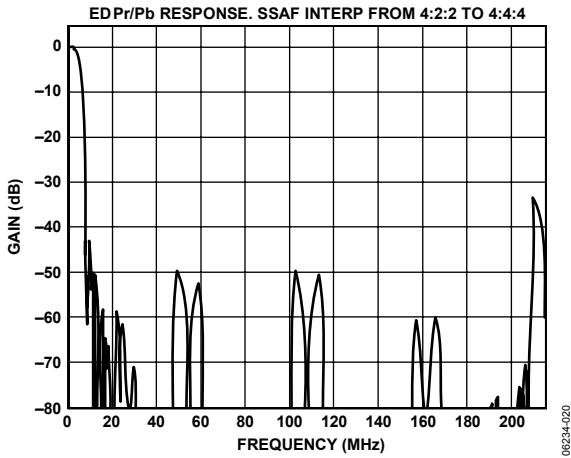

Figure 20. ED 8× Oversampling, PrPb Filter (SSAF) Response

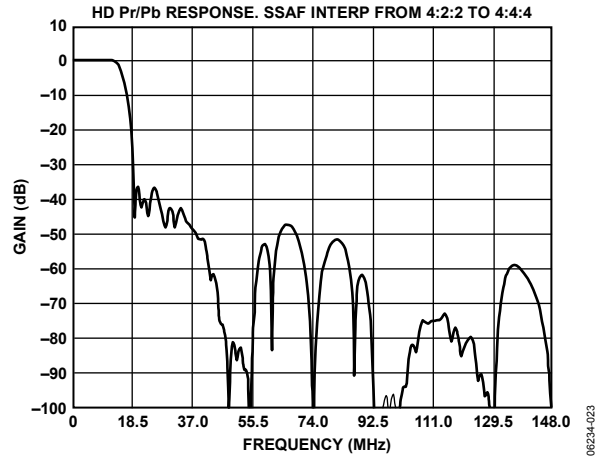

Figure 23. HD 4× Oversampling, PrPb (SSAF) Filter Response (4:2:2 Input)

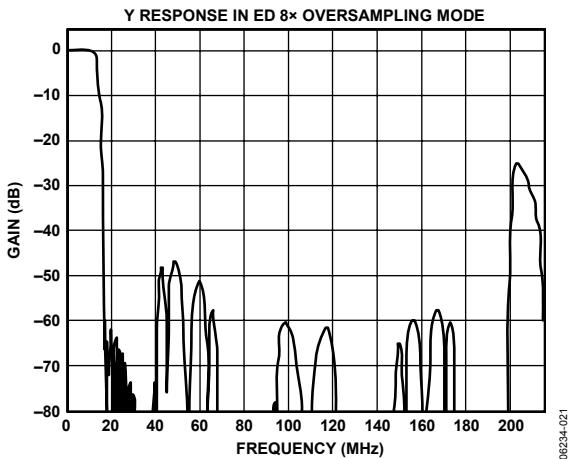

Figure 21. ED 8× Oversampling, Y Filter Response

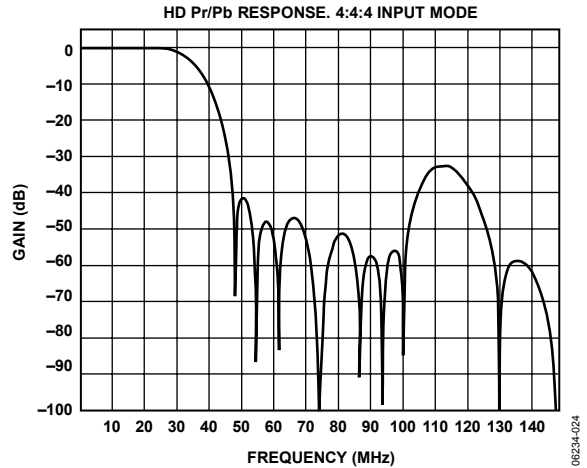

Figure 24. HD 4× Oversampling, PrPb (SSAF) Filter Response (4:4:4 Input)

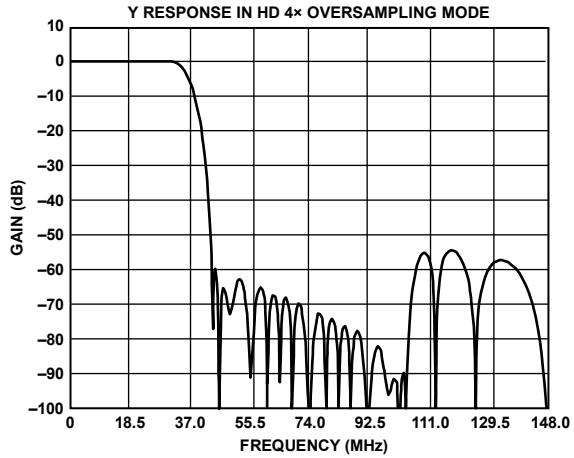

Figure 25. HD 4x Oversampling, Y Filter Response

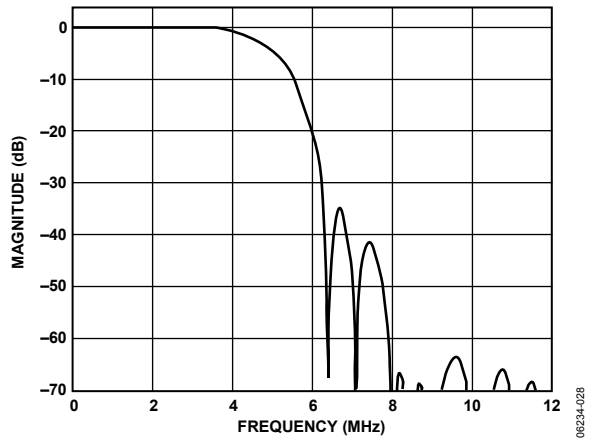

Figure 28. SD PAL, Luma Low-Pass Filter Response

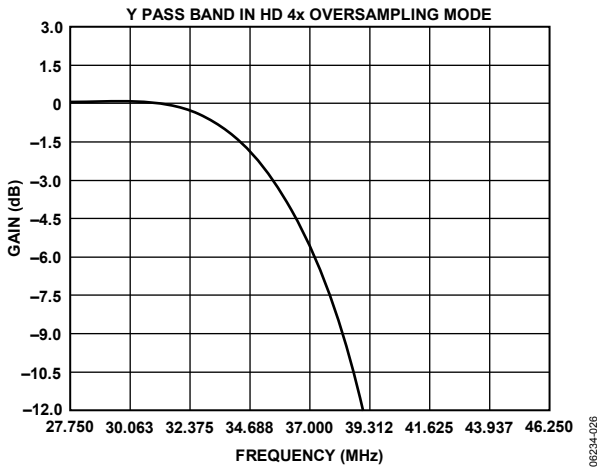

Figure 26. HD 4x Oversampling, Y Filter Response (Focus on Pass Band)

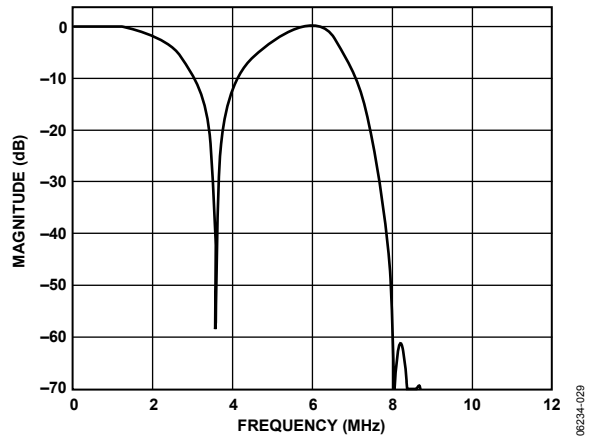

Figure 29. SD NTSC, Luma Notch Filter Response

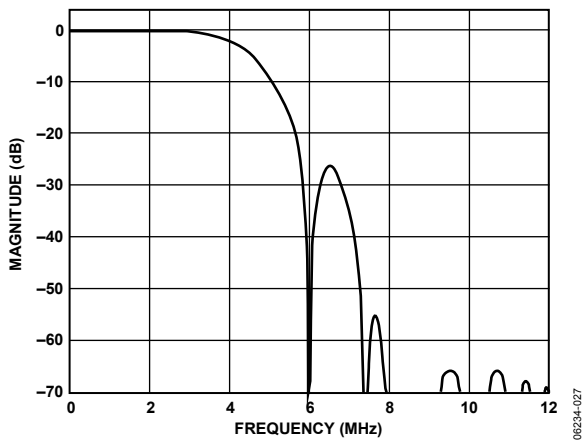

Figure 27. SD NTSC, Luma Low-Pass Filter Response

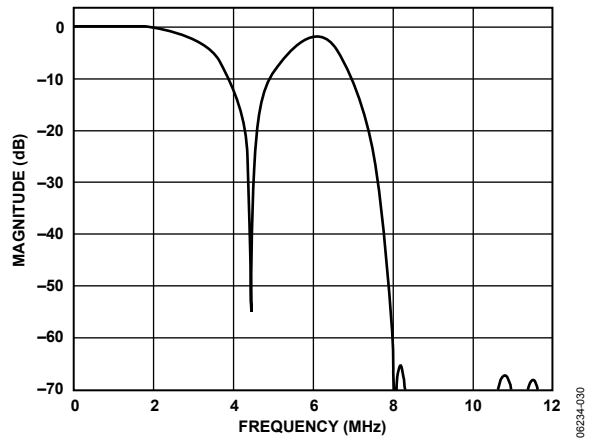

Figure 30. SD PAL, Luma Notch Filter Response

ADV7390/ADV7391/ADV7392/ADV7393

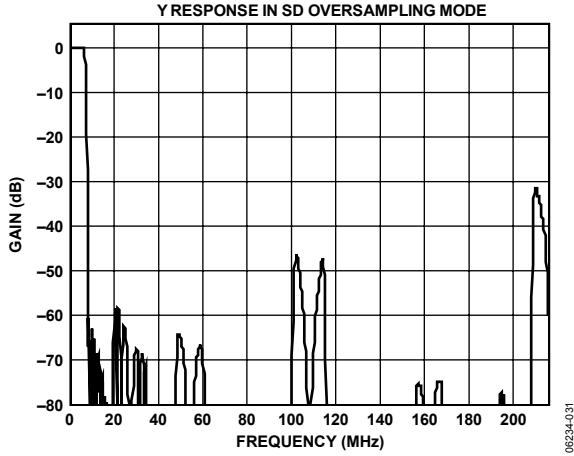

Figure 31. SD 16x Oversampling, Y Filter Response

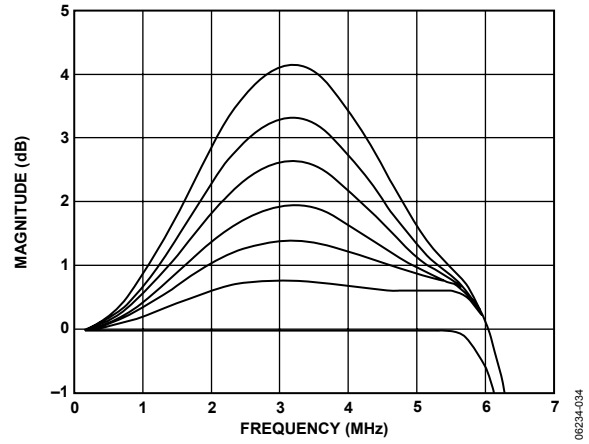

Figure 34. SD Luma SSAF Filter, Programmable Gain

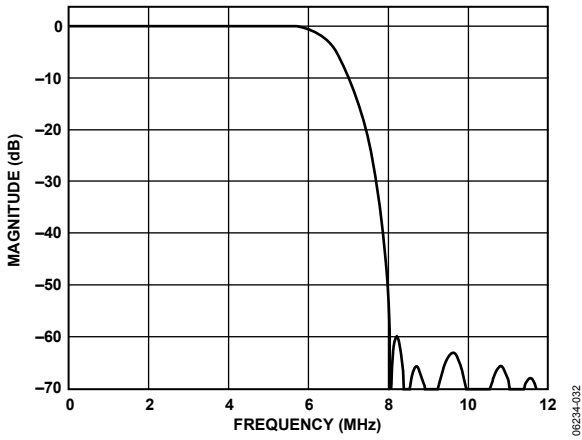

Figure 32. SD Luma SSAF Filter Response up to 12 MHz

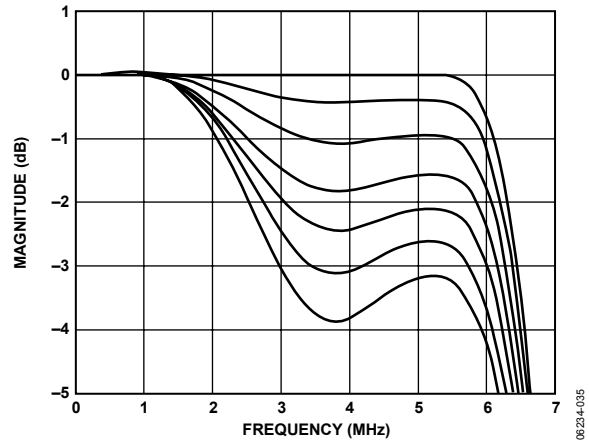

Figure 35. SD Luma SSAF Filter, Programmable Attenuation

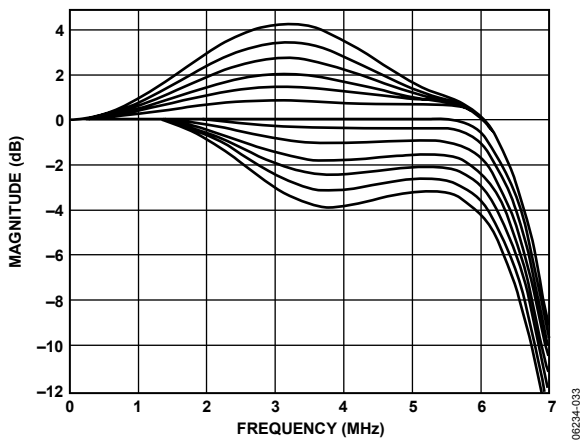

Figure 33. SD Luma SSAF Filter, Programmable Responses

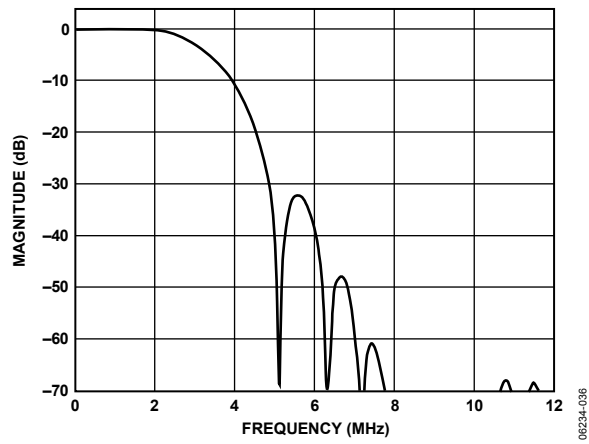

Figure 36. SD Luma CIF Low-Pass Filter Response

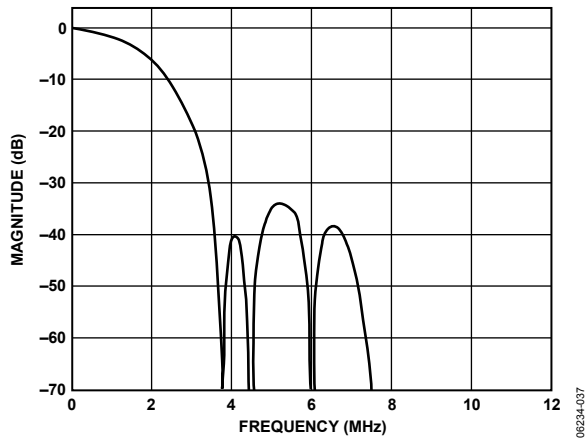

Figure 37. SD Luma QCIF Low-Pass Filter Response

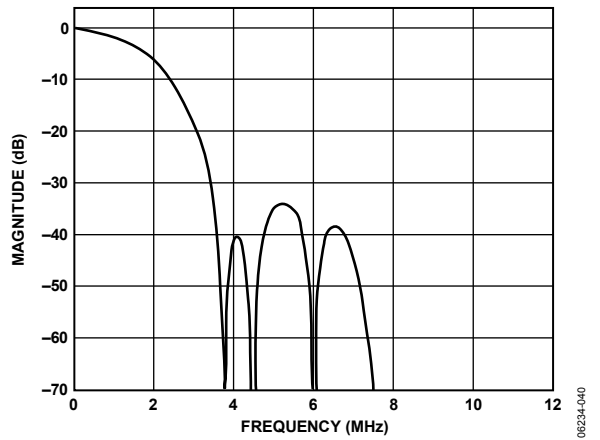

Figure 40. SD Chroma 1.3 MHz Low-Pass Filter Response

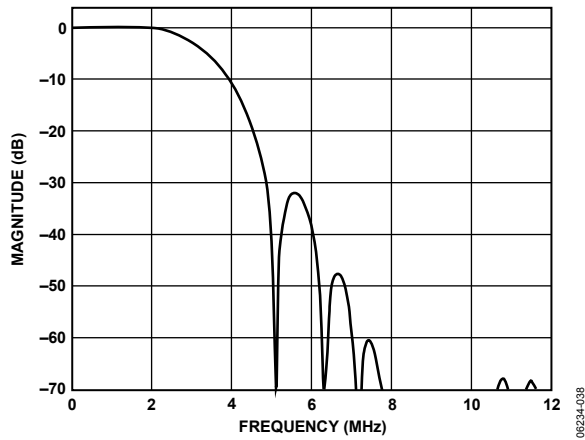

Figure 38. SD Chroma 3.0 MHz Low-Pass Filter Response

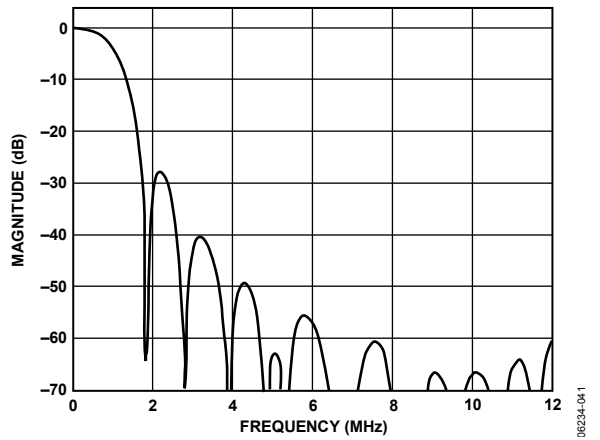

Figure 41. SD Chroma 1.0 MHz Low-Pass Filter Response

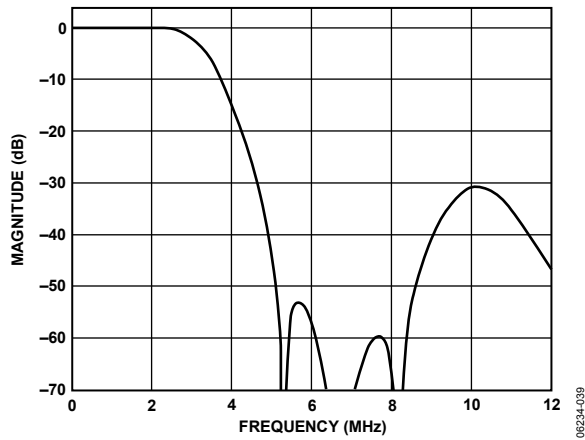

Figure 39. SD Chroma 2.0 MHz Low-Pass Filter Response

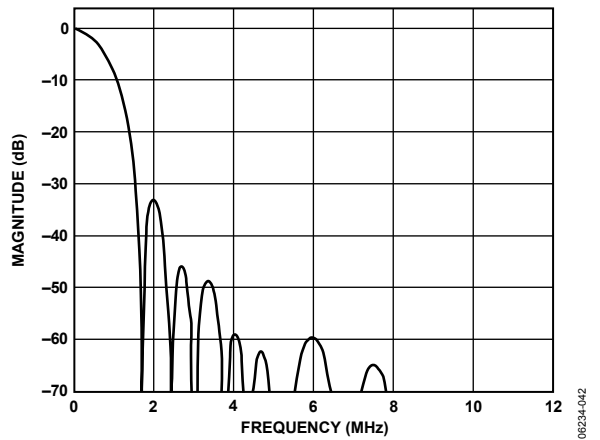

Figure 42. SD Chroma 0.65 MHz Low-Pass Filter Response

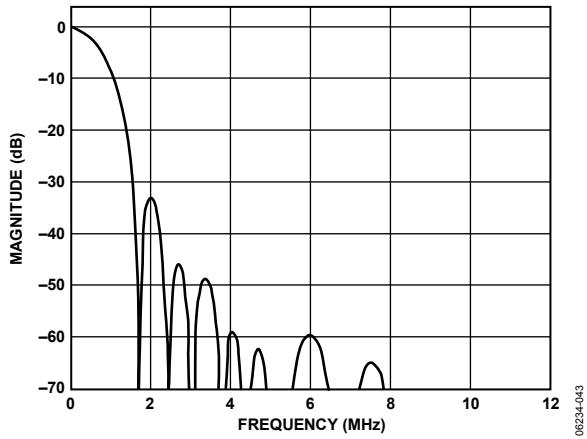

Figure 43. SD Chroma CIF Low-Pass Filter Response

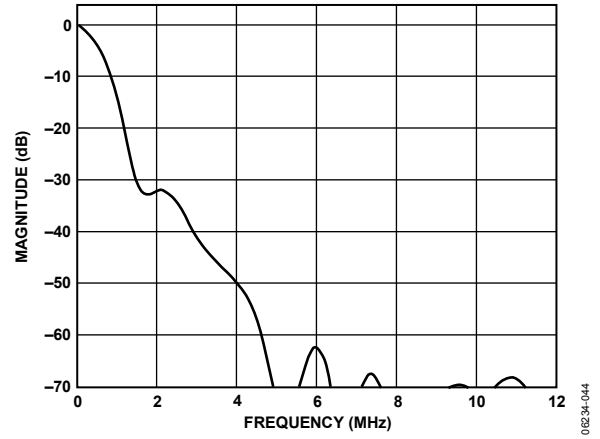

Figure 44. SD Chroma QCIF Low-Pass Filter Response

MPU PORT DESCRIPTION

Devices such as a microprocessor can communicate with the ADV739x through one of the following protocols:

- 2-wire serial (I²C-compatible) bus
- 4-wire serial (SPI-compatible) bus

After power-up or reset, the MPU port is configured for I²C operation. SPI operation can be invoked at any time by following the procedure outlined in the SPI Operation section.

I²C OPERATION

The ADV739x supports a 2-wire serial (I²C-compatible) microprocessor bus driving multiple peripherals. This port operates in an open-drain configuration. Two inputs, serial data (SDA) and serial clock (SCL), carry information between any device connected to the bus and the ADV739x. Each slave device is recognized by a unique address. The ADV739x has four possible slave addresses for both read and write operations. These are unique addresses for each device and are illustrated in Figure 45 and Figure 46. The LSB either sets a read or write operation. Logic 1 corresponds to a read operation, while Logic 0 corresponds to a write operation. A1 is controlled by setting the ALSB/SPI_SS pin of the ADV739x to Logic 0 or Logic 1.

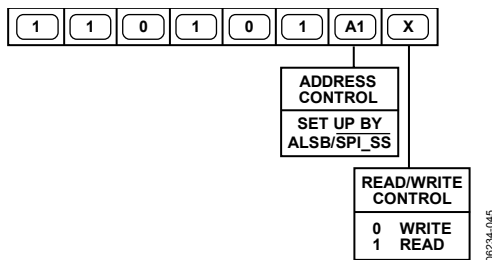

Figure 45. ADV7390/ADV7392 Slave Address = 0xD4 or 0xD6

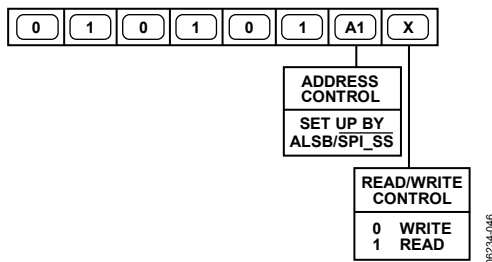

Figure 46. ADV7391/ADV7393 Slave Address = 0x54 or 0x56

To control the various devices on the bus, use the following protocol. The master initiates a data transfer by establishing a start condition, defined by a high-to-low transition on SDA while SCL remains high. This indicates that an address/data stream follows. All peripherals respond to the start condition and shift the next eight bits (7-bit address + R/W bit).

The bits are transferred from MSB down to LSB. The peripheral that recognizes the transmitted address responds by pulling the data line low during the ninth clock pulse. This is known as an acknowledge bit. All other devices withdraw from the bus at this point and maintain an idle condition. The idle condition is when the device monitors the SDA and SCL lines waiting for the start condition and the correct transmitted address. The R/W bit determines the direction of the data.

Logic 0 on the LSB of the first byte means that the master writes information to the peripheral. Logic 1 on the LSB of the first byte means that the master reads information from the peripheral.

The ADV739x acts as a standard slave device on the bus. The data on the SDA pin is eight bits long, supporting the 7-bit addresses plus the R/W bit. It interprets the first byte as the device address and the second byte as the starting subaddress. There is a subaddress auto-increment facility. This allows data to be written to or read from registers in ascending subaddress sequence starting at any valid subaddress. A data transfer is always terminated by a stop condition. The user can also access any unique subaddress register on a one-by-one basis without updating all the registers.

Stop and start conditions can be detected at any stage during the data transfer. If these conditions are asserted out of sequence with normal read and write operations, they cause an immediate jump to the idle condition. During a given SCL high period, the user should only issue a start condition, a stop condition, or a stop condition followed by a start condition. If an invalid subaddress is issued by the user, the ADV739x does not issue an acknowledge and does return to the idle condition. If the user utilizes the auto-increment method of addressing the encoder and exceeds the highest subaddress, the following actions are taken:

- In read mode, the highest subaddress register contents are output until the master device issues a no acknowledge. This indicates the end of a read. A no acknowledge condition occurs when the SDA line is not pulled low on the ninth pulse.
- In write mode, the data for the invalid byte is not loaded into any subaddress register, a no acknowledge is issued by the ADV739x, and the part returns to the idle condition.

Figure 47 shows an example of data transfer for a write sequence and the start and stop conditions. Figure 48 shows bus write and read sequences.

ADV7390/ADV7391/ADV7392/ADV7393

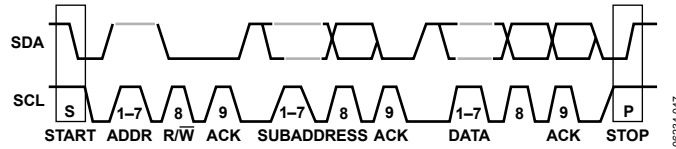

Figure 47. I²C Data Transfer

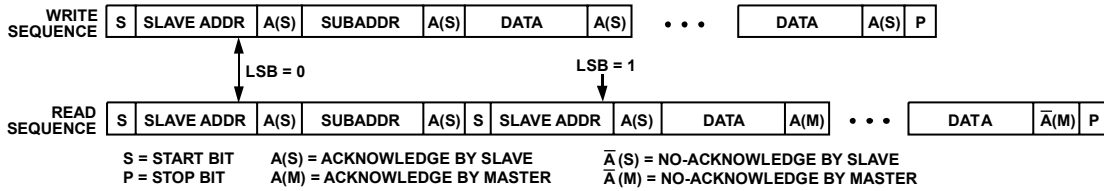

Figure 48. I²C Read and Write Sequence

SPI OPERATION

The ADV739x supports a 4-wire serial (SPI-compatible) bus connecting multiple peripherals. Two inputs, master out slave in (MOSI) and serial clock (SCLK), and one output, master in slave out (MISO), carry information between a master SPI peripheral on the bus and the ADV739x. Each slave device on the bus has a slave select pin that is connected to the master SPI peripheral by a unique slave select line. As such, slave device addressing is not required.

To invoke SPI operation, a master SPI peripheral (for example, a microprocessor) should issue three low pulses on the ADV739x ALSB/SPI_SS pin. When the encoder detects the third rising edge on the ALSB/SPI_SS pin, it automatically switches to SPI communication mode. The ADV739x remains in SPI communication mode until a hardware reset or power-down occurs.

To control the ADV739x, use the following protocol for both read and write transactions. First, the master initiates a data transfer by driving and holding the ADV739x ALSB/SPI_SS pin low. On the first SCLK rising edge after ALSB/SPI_SS has been driven low, the write command, defined as 0xD4, is written to the ADV739x over the MOSI line. The second byte written to the MOSI line is interpreted as the starting subaddress. Data on the MOSI line is written MSB first and clocked on the rising edge of SCLK.

There is a subaddress auto-increment facility. This allows data to be written to or read from registers in ascending subaddress sequence starting at any valid subaddress. The user can also access any unique subaddress register on a one-by-one basis.

In a write data transfer, 8-bit data bytes are written to the ADV739x, MSB first, on the MOSI line immediately after the starting subaddress. The data bytes are clocked into the ADV739x on the rising edge of SCLK. When all data bytes have been written, the master completes the transfer by driving and holding the ADV739x ALSB/SPI_SS pin high.

In a read data transfer, after the subaddress has been clocked in on the MOSI line, the ALSB/SPI_SS pin is driven and held high for at least one clock cycle. Then, the ALSB/SPI_SS pin is driven and held low again. On the first SCLK rising edge after ALSB/SPI_SS has been driven low, the read command, defined as 0xD5, is written, MSB first, to the ADV739x over the MOSI line. Subsequently, 8-bit data bytes are read from the ADV739x, MSB first, on the MISO line. The data bytes are clocked out of the part on the falling edge of SCLK. When all data bytes have been read, the master completes the transfer by driving and holding the ADV739x ALSB/SPI_SS pin high.

REGISTER MAP

A microprocessor can read from or write to all registers of the ADV739x via the MPU port, except for registers that are specified as read-only or write-only registers.

The subaddress register determines the register accessed by the next read or write operation. All communication through the MPU port starts with an access to the subaddress register. A read/write operation is then performed from/to the target address, incrementing to the next address until the transaction is complete.

REGISTER PROGRAMMING

Table 13 to Table 27 describe the functionality of each register. All registers can be read from as well as written to, unless otherwise stated.

SUBADDRESS REGISTER (SR7 TO SR0)

The subaddress register is an 8-bit write-only register. After the MPU port is accessed and a read/write operation is selected, the subaddress is set up. The subaddress register determines which register performs the next operation.

Table 13. Register 0x00

SR7 to SR0	Register	Bit Description	Bit Number								Register Setting	Reset Value	
			7	6	5	4	3	2	1	0			
0x00	Power Mode Register	Sleep Mode. With this control enabled, the current consumption is reduced to μ A level. All DACs and the internal PLL circuit are disabled. Registers can be read from and written to in sleep mode.									0	Sleep mode off.	0x12
										1	Sleep mode on.		
		PLL and Oversampling Control. This control allows the internal PLL circuit to be powered down and the oversampling to be switched off.							0		1	PLL on. PLL off.	
		DAC 3: Power on/off.						0				DAC 3 off. DAC 3 on.	
		DAC 2: Power on/off.					0					DAC 2 off. DAC 2 on.	
		DAC 1: Power on/off.				0						DAC 1 off. DAC 1 on.	
		Reserved.	0	0	0								

ADV7390/ADV7391/ADV7392/ADV7393

Table 14. Register 0x01 to Register 0x09

SR7 to SR0	Register	Bit Description	Bit Number							Register Setting	Reset Value			
			7	6	5	4	3	2	1			0		
0x01	Mode Select Register	Reserved.									0	0x00		
		DDR Clock Edge Alignment. Note: Only used for ED ¹ and HD DDR modes.						0	0	0	1		Reserved. Reserved. Luma clocked in on rising clock edge and chroma clocked in on falling clock edge.	
		Reserved.					0							
		Input Mode. Note: See Reg. 0x30, Bits[7:3] for ED/HD format selection.		0	0	0					0		0	SD input. ED/HD-SDR input ² ED/HD-DDR input. Reserved. Reserved. Reserved. Reserved. ED (at 54 MHz) input.
				0	0	1								
				0	1	0								
				0	1	1								
		1	0	0										
		1	0	1										
		1	1	0										
		1	1	1										
		Reserved.	0											
0x02	Mode Register 0	Reserved.							0	0	Zero must be written to these bits.	0x20		
		Test Pattern Black Bar. ³						0	1				Disabled. Enabled.	
		Manual RGB Matrix Adjust.					0	1			Disable manual RGB matrix adjust. Enable manual RGB matrix adjust.			
		Sync on RGB.				0	1						No sync. Sync on all RGB outputs.	
		RGB/YPrPb Output Select.			0	1					RGB component outputs. YPrPb component outputs.			
		SD Sync Output Enable.		0	1								No sync output. Output SD syncs on $\overline{\text{HSYNC}}$ and $\overline{\text{VSYNC}}$ pins.	
		ED/HD Sync Output Enable.	0	1							No sync output. Output ED/HD syncs on $\overline{\text{HSYNC}}$ and $\overline{\text{VSYNC}}$ pins.			
0x03	ED/HD CSC Matrix 0							x	x	LSBs for GY.	0x03			
0x04	ED/HD CSC Matrix 1			x	x	x	x	x	x	LSBs for RV. LSBs for BU. LSBs for GV. LSBs for GU.	0xF0			
0x05	ED/HD CSC Matrix 2	x	x	x	x	x	x	x	x	Bits[9:2] for GY.	0x4E			
0x06	ED/HD CSC Matrix 3	x	x	x	x	x	x	x	x	Bits[9:2] for GU.	0x0E			
0x07	ED/HD CSC Matrix 4	x	x	x	x	x	x	x	x	Bits[9:2] for GV.	0x24			
0x08	ED/HD CSC Matrix 5	x	x	x	x	x	x	x	x	Bits[9:2] for BU.	0x92			
0x09	ED/HD CSC Matrix 6	x	x	x	x	x	x	x	x	Bits[9:2] for RV.	0x7C			

¹ ED = enhanced definition = 525p and 625p.

² Available on the ADV7392/ADV7393 (40-pin devices) only.

³ Subaddress 0x31, Bit 2 must also be enabled (ED/HD). Subaddress 0x84, Bit 6 must also be enabled (SD).

Table 15. Register 0x0B to Register 0x17

SR7 to SR0	Register	Bit Description	Bit Number							Register Setting	Reset Value	
			7	6	5	4	3	2	1			0
0x0B	DAC 1, DAC 2, DAC 3 Output Level	Positive Gain to DAC Output Voltage.	0	0	0	0	0	0	0	0	0%	0x00
			0	0	0	0	0	0	0	1	+0.018%	
			0	0	0	0	0	0	1	0	+0.036%	
			
			0	0	1	1	1	1	1	1	+7.382%	
		0	1	0	0	0	0	0	0	+7.5%		
		Negative Gain to DAC Output Voltage.	1	1	0	0	0	0	0	-7.5%		
			1	1	0	0	0	0	1	-7.382%		
			1	0	0	0	0	0	1	-7.364%		
				
1	1		1	1	1	1	1	-0.018%				
0x0D	DAC Power Mode	DAC 1 Low Power Mode.							0	DAC 1 low power disabled	0x00	
									1	DAC 1 low power enabled		
		DAC 2 Low Power Mode.							0	DAC 2 low power disabled		
									1	DAC 2 low power enabled		
		DAC 3 Low Power Mode.						0		DAC 3 low power disabled		
						1		DAC 3 low power enabled				
SD/ED Oversample Rate Select.					0			SD = 16x, ED = 8x				
					1			SD = 8x, ED = 4x				
Reserved.	0	0	0	0								
0x10	Cable Detection	DAC 1 Cable Detect. Read Only.							0	Cable detected on DAC 1	0x00	
									1	DAC 1 unconnected		
		DAC 2 Cable Detect. Read Only.							0	Cable detected on DAC 2		
									1	DAC 2 unconnected		
		Reserved.					0	0				
Unconnected DAC auto power-down.				0					DAC auto power-down disable			
				1					DAC auto power-down enable			
	Reserved.	0	0	0								
0x13	Pixel Port Readback A ¹	P[7:0] Readback (ADV7390/ADV7391). P[15:8] Readback (ADV7392/ADV7393).	x	x	x	x	x	x	x	x	Read only	0xXX
0x14	Pixel Port Readback B ¹	P[7:0] Readback (ADV7392/ADV7393).	x	x	x	x	x	x	x	x	Read only	0xXX
0x16	Control Port Readback ¹	Reserved.						x	x	x	Read only	0xXX
		VSYNC Readback.					x					
		HSYNC Readback.				x						
		SFL/MISO Readback.			x							
		Reserved.	x	x								
0x17	Software Reset	Reserved.								0	0x00	
		Software Reset.							0	Writing a 1 resets the device; this is a self-clearing bit		
								1				
Reserved.	0	0	0	0	0	0						

¹ For correct operation, Subaddress 0x01[6:4] must equal the default value of 000.

ADV7390/ADV7391/ADV7392/ADV7393

Table 16. Register 0x30

SR7 to SR0	Register	Bit Description	Bit Number								Register Setting	Note	Reset Value	
			7	6	5	4	3	2	1	0				
0x30	ED/HD Mode Register 1	ED/HD Output Standard.									0 0	EIA-770.2 output EIA-770.3 output	ED HD	0x00
										0 1	EIA-770.1 output			
										1 0	Output levels for full input range			
		ED/HD Input Synchronization Format.								0	External HSYNC, VSYNC and field inputs ¹			
										1	Embedded EAV/SAV codes			
		ED/HD Input Mode.	0 0	0 0	0 0	0 1	0 0				SMPTE 293M, ITU-BT.1358 Nonstandard timing mode	525p @ 59.94 Hz		
			0 0	0 0	0 1	0 0					BTA-1004, ITU-BT.1362	525p @ 59.94 Hz		
			0 0	0 0	0 1	0 1					ITU-BT.1358	625p @ 50 Hz		
			0 0	0 1	0 0	0 0					ITU-BT.1362	625p @ 50 Hz		
			0 0	0 1	0 0	0 1					SMPTE 296M-1, SMPTE 274M-2	720p @ 60 Hz/59.94 Hz		
			0 0	0 1	0 1	0 0					SMPTE 296M-3	720p @ 50 Hz		
			0 0	0 1	0 1	0 1					SMPTE 296M-4, SMPTE 274M-5	720p @ 30 Hz/29.97 Hz		
			0 1	0 0	0 0	0 0					SMPTE 296M-6	720p @ 25 Hz		
			0 1	0 0	0 0	0 1					SMPTE 296M-7, SMPTE 296M-8	720p @ 24 Hz/23.98 Hz		
			0 1	0 0	0 1	0 0					SMPTE 240M	1035i @ 60 Hz/59.94 Hz		
			0 1	0 0	0 1	0 1					Reserved			
			0 1	0 1	0 0	0 0					Reserved			
			0 1	0 1	0 0	0 1					SMPTE 274M-4, SMPTE 274M-5	1080i @ 30 Hz/29.97 Hz		
			0 1	0 1	0 1	0 0					SMPTE 274M-6	1080i @ 25 Hz		
			0 1	0 1	0 1	0 1					SMPTE 274M-7, SMPTE 274M-8	1080p @ 30 Hz/29.97 Hz		
			1 0	0 0	0 0	0 0					SMPTE 274M-9	1080p @ 25 Hz		
			1 0	0 0	0 0	0 1					SMPTE 274M-10, SMPTE 274M-11	1080p @ 24 Hz/23.98 Hz		
			1 0	0 0	0 1	0 0					ITU-R BT.709-5	1080Psf @ 24 Hz		
			10011 to 11111									Reserved		

¹ Synchronization can be controlled with a combination of either HSYNC and VSYNC inputs or HSYNC and field inputs, depending on Subaddress 0x34, Bit 6.

Table 17. Register 0x31 to Register 0x33

SR7 to SR0	Register	Bit Description	Bit Number								Register Setting	Reset Value			
			7	6	5	4	3	2	1	0					
0x31	ED/HD Mode Register 2	ED/HD Pixel Data Valid.									0	Pixel data valid off	0x00		
											1	Pixel data valid on			
		HD Oversample Rate Select.									0	4×			
											1	2×			
		ED/HD Test Pattern Enable.									0	HD test pattern off			
											1	HD test pattern on			
		ED/HD Test Pattern Hatch/Field.								0	Hatch				
								1	Field/frame						
ED/HD Vertical Blanking Interval (VBI) Open.							0	Disabled							
							1	Enabled							
ED/HD Undershoot Limiter.			0	0						Disabled					
			0	1						-11 IRE					
			1	0						-6 IRE					
			1	1						-1.5 IRE					
ED/HD Sharpness Filter.		0								Disabled					
		1								Enabled					
0x32	ED/HD Mode Register 3	ED/HD Y Delay with Respect to Falling Edge of HSYNC.							0	0	0	0 clock cycles	0x00		
										0	0	1		1 clock cycle	
											0	1		0	2 clock cycles
											0	1		1	3 clock cycles
											1	0		0	4 clock cycles
		ED/HD Color Delay with Respect to Falling Edge of HSYNC.			0	0	0							0 clock cycles	
					0	0	1							1 clock cycle	
		0	1	0							2 clock cycles				
		0	1	1							3 clock cycles				
		1	0	0							4 clock cycles				
ED/HD CGMS Enable.		0									Disabled				
		1									Enabled				
ED/HD CGMS CRC Enable.		0									Disabled				
		1									Enabled				
0x33	ED/HD Mode Register 4	ED/HD Cr/Cb Sequence.									0	Cb after falling edge of HSYNC	0x68		
											1	Cr after falling edge of HSYNC			
		Reserved.									0	0 must be written to this bit			
		ED/HD Input Format.								0		8-bit input			
										1		10-bit input ¹			
		Sinc Compensation Filter on DAC 1, DAC 2, DAC 3.								0		Disabled			
										1		Enabled			
Reserved.				0						0 must be written to this bit					
ED/HD Chroma SSAF Filter.			0							Disabled					
			1							Enabled					
Reserved.		1								1 must be written to this bit					
ED/HD Double Buffering.		0								Disable					
		1								Enabled					

¹ Available on the ADV7392/ADV7393 (40-pin devices) only.

ADV7390/ADV7391/ADV7392/ADV7393

Table 18. Register 0x34 to Register 0x38

SR7 to SR0	Register	Bit Description	Bit Number								Register Setting	Reset Value	
			7	6	5	4	3	2	1	0			
0x34	ED/HD Mode Register 5	ED/HD Timing Reset.									0 1	Internal ED/HD timing counters enabled Resets the internal ED/HD timing counters	0x48
		ED/HD HSYNC Control. ¹									0 1	HSYNC output control (refer to Table 50)	
		ED/HD VSYNC Control. ¹									0 1	VSYNC output control (refer to Table 51)	
		Reserved.									1		
		ED Macrovision Enable. ²									0 1	ED Macrovision disabled ED Macrovision enabled	
		Reserved.									0	0 must be written to this bit	
		ED/HD VSYNC Input/Field Input.									0 1	0 = Field input 1 = VSYNC input	
		ED/HD Horizontal/Vertical Counter Mode. ³									0 1	Update field/line counter Field/line counter free running	
0x35	ED/HD Mode Register 6	Reserved.									0		0x00
		Reserved.									0		
		ED/HD Sync on PrPb.									0 1	Disabled Enabled	
		ED/HD Color DAC Swap.									0 1	DAC 2 = Pb, DAC 3 = Pr DAC 2 = Pr, DAC 3 = Pb	
		ED/HD Gamma Correction Curve Select.									0 1	Gamma Correction Curve A Gamma Correction Curve B	
		ED/HD Gamma Correction Enable.									0 1	Disabled Enabled	
		ED/HD Adaptive Filter Mode.									0 1	Mode A Mode B	
		ED/HD Adaptive Filter Enable.									0 1	Disabled Enabled	
0x36	ED/HD Y Level ⁴	ED/HD Test Pattern Y Level.	x	x	x	x	x	x	x	x	Y level value	0xA0	
0x37	ED/HD Cr Level ⁴	ED/HD Test Pattern Cr Level.	x	x	x	x	x	x	x	x	Cr level value	0x80	
0x38	ED/HD Cb Level ⁴	ED/HD Test Pattern Cb Level.	x	x	x	x	x	x	x	x	Cb level value	0x80	

¹ Used in conjunction with ED/HD sync output enable in Subaddress 0x02, Bit 7 = 1.

² Applies to the ADV7390 and ADV7392 only.

³ When set to 0, the horizontal/vertical counters automatically wrap around at the end of the line/field/frame of the selected standard. When set to 1, the horizontal/vertical counters are free running and wrap around when external sync signals indicate to do so.

⁴ For use with ED/HD internal test patterns only (Subaddress 0x31, Bit 2 = 1).

Table 19. Register 0x39 to Register 0x43

SR7 to SR0	Register	Bit Description	Bit Number								Register Setting	Reset Value	
			7	6	5	4	3	2	1	0			
0x39	ED/HD Mode Register 7	Reserved.				0	0	0	0	0		0x00	
		ED/HD EIA/CEA-861B Synchronization Compliance.			0 1								Disabled Enabled
		Reserved.	0	0									
0x40	ED/HD Sharpness Filter Gain	ED/HD Sharpness Filter Gain Value A.					0 0 ... 0 1 ... 1	0 0 ... 1 1	0 0 ... 1 1	0 1 ... 1 1	Gain A = 0 Gain A = +1 ... Gain A = +7 Gain A = -8 ... Gain A = -1	0x00	
		ED/HD Sharpness Filter Gain Value B.	0 0 ... 0 1 ... 1	0 0 ... 1 0 ... 1	0 0 ... 1 0 ... 1	0 1 ... 0 0 ... 1					Gain B = 0 Gain B = +1 ... Gain B = +7 Gain B = -8 ... Gain B = -1		
0x41	ED/HD CGMS Data 0	ED/HD CGMS Data Bits.	0	0	0	0	C19	C18	C17	C16	CGMS C19 to C16	0x00	
0x42	ED/HD CGMS Data 1	ED/HD CGMS Data Bits.	C15	C14	C13	C12	C11	C10	C9	C8	CGMS C15 to C8	0x00	
0x43	ED/HD CGMS Data 2	ED/HD CGMS Data Bits.	C7	C6	C5	C4	C3	C2	C1	C0	CGMS C7 to C0	0x00	

Table 20. Register 0x44 to Register 0x57

SR7 to SR0	Register	Bit Description	Bit Number								Register Setting	Reset Value
			7	6	5	4	3	2	1	0		
0x44	ED/HD Gamma A0	ED/HD Gamma Curve A (Point 24).	x	x	x	x	x	x	x	x	A0	0x00
0x45	ED/HD Gamma A1	ED/HD Gamma Curve A (Point 32).	x	x	x	x	x	x	x	x	A1	0x00
0x46	ED/HD Gamma A2	ED/HD Gamma Curve A (Point 48).	x	x	x	x	x	x	x	x	A2	0x00
0x47	ED/HD Gamma A3	ED/HD Gamma Curve A (Point 64).	x	x	x	x	x	x	x	x	A3	0x00
0x48	ED/HD Gamma A4	ED/HD Gamma Curve A (Point 80).	x	x	x	x	x	x	x	x	A4	0x00
0x49	ED/HD Gamma A5	ED/HD Gamma Curve A (Point 96).	x	x	x	x	x	x	x	x	A5	0x00
0x4A	ED/HD Gamma A6	ED/HD Gamma Curve A (Point 128).	x	x	x	x	x	x	x	x	A6	0x00
0x4B	ED/HD Gamma A7	ED/HD Gamma Curve A (Point 160).	x	x	x	x	x	x	x	x	A7	0x00
0x4C	ED/HD Gamma A8	ED/HD Gamma Curve A (Point 192).	x	x	x	x	x	x	x	x	A8	0x00
0x4D	ED/HD Gamma A9	ED/HD Gamma Curve A (Point 224).	x	x	x	x	x	x	x	x	A9	0x00
0x4E	ED/HD Gamma B0	ED/HD Gamma Curve B (Point 24).	x	x	x	x	x	x	x	x	B0	0x00
0x4F	ED/HD Gamma B1	ED/HD Gamma Curve B (Point 32).	x	x	x	x	x	x	x	x	B1	0x00
0x50	ED/HD Gamma B2	ED/HD Gamma Curve B (Point 48).	x	x	x	x	x	x	x	x	B2	0x00
0x51	ED/HD Gamma B3	ED/HD Gamma Curve B (Point 64).	x	x	x	x	x	x	x	x	B3	0x00
0x52	ED/HD Gamma B4	ED/HD Gamma Curve B (Point 80).	x	x	x	x	x	x	x	x	B4	0x00
0x53	ED/HD Gamma B5	ED/HD Gamma Curve B (Point 96).	x	x	x	x	x	x	x	x	B5	0x00
0x54	ED/HD Gamma B6	ED/HD Gamma Curve B (Point 128).	x	x	x	x	x	x	x	x	B6	0x00
0x55	ED/HD Gamma B7	ED/HD Gamma Curve B (Point 160).	x	x	x	x	x	x	x	x	B7	0x00
0x56	ED/HD Gamma B8	ED/HD Gamma Curve B (Point 192).	x	x	x	x	x	x	x	x	B8	0x00
0x57	ED/HD Gamma B9	ED/HD Gamma Curve B (Point 224).	x	x	x	x	x	x	x	x	B9	0x00

ADV7390/ADV7391/ADV7392/ADV7393

Table 21. Register 0x58 to Register 0x5D

SR7 to SR0	Register	Bit Description	Bit Number							Register Setting	Reset Value	
			7	6	5	4	3	2	1			0
0x58	ED/HD Adaptive Filter Gain 1	ED/HD Adaptive Filter Gain 1, Value A.					0	0	0	0	Gain A = 0	0x00
						0	0	0	1	Gain A = +1		
							
						0	1	1	1	Gain A = +7		
						1	0	0	0	Gain A = -8		
							
						1	1	1	1	Gain A = -1		
		ED/HD Adaptive Filter Gain 1, Value B.	0	0	0	0				Gain B = 0		
			0	0	0	1				Gain B = +1		
				
			0	1	1	1				Gain B = +7		
			1	0	0	0				Gain B = -8		
				
			1	1	1	1				Gain B = -1		
0x59	ED/HD Adaptive Filter Gain 2	ED/HD Adaptive Filter Gain 2, Value A.					0	0	0	0	Gain A = 0	0x00
						0	0	0	1	Gain A = +1		
							
						0	1	1	1	Gain A = +7		
						1	0	0	0	Gain A = -8		
							
						1	1	1	1	Gain A = -1		
		ED/HD Adaptive Filter Gain 2, Value B.	0	0	0	0				Gain B = 0		
			0	0	0	1				Gain B = +1		
				
			0	1	1	1				Gain B = +7		
			1	0	0	0				Gain B = -8		
				
			1	1	1	1				Gain B = -1		
0x5A	ED/HD Adaptive Filter Gain 3	ED/HD Adaptive Filter Gain 3, Value A.					0	0	0	0	Gain A = 0	0x00
						0	0	0	1	Gain A = +1		
							
						0	1	1	1	Gain A = +7		
						1	0	0	0	Gain A = -8		
							
						1	1	1	1	Gain A = -1		
		ED/HD Adaptive Filter Gain 3, Value B.	0	0	0	0				Gain B = 0		
			0	0	0	1				Gain B = +1		
				
			0	1	1	1				Gain B = +7		
			1	0	0	0				Gain B = -8		
				
			1	1	1	1				Gain B = -1		
0x5B	ED/HD Adaptive Filter Threshold A	ED/HD Adaptive Filter Threshold A.	x	x	x	x	x	x	x	x	Threshold A	0x00
0x5C	ED/HD Adaptive Filter Threshold B	ED/HD Adaptive Filter Threshold B.	x	x	x	x	x	x	x	x	Threshold B	0x00
0x5D	ED/HD Adaptive Filter Threshold C	ED/HD Adaptive Filter Threshold C.	x	x	x	x	x	x	x	x	Threshold C	0x00

Table 22. Register 0x5E to Register 0x6E

SR7 to SR0	Register	Bit Description	Bit Number								Register Setting	Reset Value	
			7	6	5	4	3	2	1	0			
0x5E	ED/HD CGMS Type B Register 0	ED/HD CGMS Type B Enable.									0 1	Disabled Enabled	0x00
		ED/HD CGMS Type B CRC Enable.								0 1	Disabled Enabled		
		ED/HD CGMS Type B Header Bits.	H5	H4	H3	H2	H1	H0			H5 to H0		
0x5F	ED/HD CGMS Type B Register 1	ED/HD CGMS Type B Data Bits.	P7	P6	P5	P4	P3	P2	P1	P0	P7 to P0	0x00	
0x60	ED/HD CGMS Type B Register 2	ED/HD CGMS Type B Data Bits.	P15	P14	P13	P12	P11	P10	P9	P8	P15 to P8	0x00	
0x61	ED/HD CGMS Type B Register 3	ED/HD CGMS Type B Data Bits.	P23	P22	P21	P20	P19	P18	P17	P16	P23 to P16	0x00	
0x62	ED/HD CGMS Type B Register 4	ED/HD CGMS Type B Data Bits.	P31	P30	P29	P28	P27	P26	P25	P24	P31 to P24	0x00	
0x63	ED/HD CGMS Type B Register 5	ED/HD CGMS Type B Data Bits.	P39	P38	P37	P36	P35	P34	P33	P32	P39 to P32	0x00	
0x64	ED/HD CGMS Type B Register 6	ED/HD CGMS Type B Data Bits.	P47	P46	P45	P44	P43	P42	P41	P40	P47 to P40	0x00	
0x65	ED/HD CGMS Type B Register 7	ED/HD CGMS Type B Data Bits.	P55	P54	P53	P52	P51	P50	P49	P48	P55 to P48	0x00	
0x66	ED/HD CGMS Type B Register 8	ED/HD CGMS Type B Data Bits.	P63	P62	P61	P60	P59	P58	P57	P56	P63 to P56	0x00	
0x67	ED/HD CGMS Type B Register 9	ED/HD CGMS Type B Data Bits.	P71	P70	P69	P68	P67	P66	P65	P64	P71 to P64	0x00	
0x68	ED/HD CGMS Type B Register 10	ED/HD CGMS Type B Data Bits.	P79	P78	P77	P76	P75	P74	P73	P72	P79 to P72	0x00	
0x69	ED/HD CGMS Type B Register 11	ED/HD CGMS Type B Data Bits.	P87	P86	P85	P84	P83	P82	P81	P80	P87 to P80	0x00	
0x6A	ED/HD CGMS Type B Register 12	ED/HD CGMS Type B Data Bits.	P95	P94	P93	P92	P91	P90	P89	P88	P95 to P88	0x00	
0x6B	ED/HD CGMS Type B Register 13	ED/HD CGMS Type B Data Bits.	P103	P102	P101	P100	P99	P98	P97	P96	P103 to P96	0x00	
0x6C	ED/HD CGMS Type B Register 14	ED/HD CGMS Type B Data Bits.	P111	P110	P109	P108	P107	P106	P105	P104	P111 to P104	0x00	
0x6D	ED/HD CGMS Type B Register 15	ED/HD CGMS Type B Data Bits.	P119	P118	P117	P116	P115	P114	P113	P112	P119 to P112	0x00	
0x6E	ED/HD CGMS Type B Register 16	ED/HD CGMS Type B Data Bits.	P127	P126	P125	P124	P123	P122	P121	P120	P127 to P120	0x00	

ADV7390/ADV7391/ADV7392/ADV7393

Table 23. Register 0x80 to Register 0x83

SR7 to SR0	Register	Bit Description	Bit Number								Register Setting	Reset Value	
			7	6	5	4	3	2	1	0			
0x80	SD Mode Register 1	SD Standard.								0	0	NTSC	0x10
										0	1	PAL B, PAL D, PAL G, PAL H, PAL I	
										1	0	PAL M	
		SD Luma Filter.				0	0	0				LPF NTSC	
						0	0	1				LPF PAL	
						0	1	0				Notch NTSC	
						0	1	1				Notch PAL	
						1	0	0				Luma SSAF	
						1	0	1				Luma CIF	
						1	1	0				Luma QCIF	
						1	1	1				Reserved	
		SD Chroma Filter.	0	0	0							1.3 MHz	
			0	0	1							0.65 MHz	
			0	1	0							1.0 MHz	
			0	1	1							2.0 MHz	
			1	0	0							Reserved	
			1	0	1							Chroma CIF	
			1	1	0							Chroma QCIF	
			1	1	1							3.0 MHz	
0x82	SD Mode Register 2	SD PrPb SSAF Filter.									0	Disabled	0x0B
											1	Enabled	
		SD DAC Output 1.									0	Refer to Table 32 in the Output Configuration section	
											1		
		Reserved.								0			
		SD Pedestal.						0				Disabled	
								1				Enabled	
		SD Square Pixel Mode.					0					Disabled	
					1					Enabled			
SD VCR FF/RW Sync.				0						Disabled			
				1						Enabled			
SD Pixel Data Valid.			0							Disabled			
			1							Enabled			
SD Active Video Edge Control.	0									Disabled			
	1									Enabled			
0x83	SD Mode Register 3	SD Pedestal YPrPb Output.									0	No pedestal on YPrPb	0x04
											1	7.5 IRE pedestal on YPrPb	
		SD Output Levels Y.									0	Y = 700 mV/300 mV	
											1	Y = 714 mV/286 mV	
		SD Output Levels PrPb.						0	0			700 mV p-p (PAL), 1000 mV p-p (NTSC)	
								0	1			700 mV p-p	
								1	0			1000 mV p-p	
						1	1			648 mV p-p			
SD Vertical Blanking Interval (VBI) Open.					0					Disabled			
					1					Enabled			
SD Closed Captioning Field Control.		0	0							Closed captioning disabled			
		0	1							Closed captioning on odd field only			
		1	0							Closed captioning on even field only			
		1	1							Closed captioning on both fields			
Reserved.	0									Reserved			

Table 24. Register 0x84 to Register 0x87

SR7 to SR0	Register	Bit Description	Bit Number								Register Setting	Reset Value		
			7	6	5	4	3	2	1	0				
0x84	SD Mode Register 4	SD VSYNC-3H.									0	Disabled	0x00	
										1	$\overline{\text{VSYNC}}= 2.5$ lines (PAL), VSYNC= 3 lines (NTSC)			
		SD SFL/SCR/TR Mode Select.						0	0	0	0	Disabled		
								1	0	1	0	Subcarrier reset mode enabled		
								1	1	1	1	Timing reset mode enabled		
												SFL mode enabled		
								0		1		720 pixels		
										710 (NTSC), 702 (PAL)				
		SD Chroma.				0		1		Chroma enabled				
						1				Chroma disabled				
		SD Burst.			0					Enabled				
					1					Disabled				
		SD Color Bars.		0						Disabled				
				1						Enabled				
		SD Luma/Chroma Swap.	0							DAC 2 = luma, DAC 3 = chroma				
			1							DAC 2 = chroma, DAC 3 = luma				
0x86	SD Mode Register 5	NTSC Color Subcarrier Adjust (Delay from the falling edge of output HSYNC pulse to start of color burst).								0	0	5.17 μs	0x02	
										0	1	5.31 μs		
											1	0		5.59 μs (must be set for Macrovision compliance)
											1	1		Reserved
		Reserved.							0					
		SD EIA/CEA-861B Synchronization Compliance.						0		1		Disabled		
								1				Enabled		
		Reserved.			0	0								
		SD Horizontal/Vertical Counter Mode. ¹		0							Update field/line counter			
				1							Field/line counter free running			
		SD RGB Color Swap. ²	0								Normal			
			1								Color reversal enabled			
0x87	SD Mode Register 6	SD PrPb Scale.									0	Disabled	0x00	
											1	Enabled		
		SD Y Scale.								0		Disabled		
										1		Enabled		
		SD Hue Adjust.							0			Disabled		
									1			Enabled		
		SD Brightness.						0				Disabled		
								1				Enabled		
		SD Luma SSAF Gain.				0					Disabled			
						1					Enabled			
		SD Input Standard Auto Detection.			0						Disabled			
					1						Enabled			
		Reserved.		0							0 must be written to this bit			
		SD RGB Input Enable. ²	0								SD YCrCb input			
			1								SD RGB input			

¹ When set to 0, the horizontal/vertical counters automatically wrap around at the end of the line/field/frame of the selected standard. When set to 1, the horizontal/vertical counters are free running and wrap around when external sync signals indicate to do so.

² Available on the ADV7392/ADV7393 (40-pin devices) only.

ADV7390/ADV7391/ADV7392/ADV7393

Table 25. Register 0x88 to Register 0x89

SR7 to SR0	Register	Bit Description	Bit Number							Register Setting	Reset Value	
			7	6	5	4	3	2	1			0
0x88	SD Mode Register 7	Reserved.									0	0x00
		SD Noninterlaced Mode.							0 1		Disabled Enabled	
		SD Double Buffering.						0 1		Disabled Enabled		
		SD Input Format.				0 0 1 1	0 1 0 1			8-bit input 16-bit input ¹ 10-bit input ¹ Reserved		
		SD Digital Noise Reduction.			0 1					Disabled Enabled		
		SD Gamma Correction Enable.		0 1						Disabled Enabled		
		SD Gamma Correction Curve Select.	0 1							Gamma Correction Curve A Gamma Correction Curve B		
0x89	SD Mode Register 8	SD Undershoot Limiter.							0 0 1 1	0 1 0 1	Disabled -11 IRE -6 IRE -1.5 IRE	0x00
		Reserved.						0		0 must be written to this bit		
		SD Black Burst Output on DAC Luma.					0 1		Disabled Enabled			
		SD Chroma Delay.			0 0 1 1	0 1 0 1			Disabled 4 clock cycles 8 clock cycles Reserved			
		Reserved.	0 0							0 must be written to these bits		

¹ Available on the ADV7392/ADV7393 (40-pin devices) only.

Table 26. Register 0x8A to Register 0x98

SR7 to SR0	Register	Bit Description	Bit Number							Register Setting	Reset Value		
			7	6	5	4	3	2	1			0	
0x8A	SD Timing Register 0	SD Slave/Master Mode.									0 1	Slave mode Master mode	0x08
		SD Timing Mode.						0 0 1 1	0 1 0 1		Mode 0 Mode 1 Mode 2 Mode 3		
		Reserved.					1						
		SD Luma Delay.			0 0 1 1	0 1 0 1					No delay 2 clock cycles 4 clock cycles 6 clock cycles		
		SD Minimum Luma Value.		0 1							-40 IRE -7.5 IRE		
		SD Timing Reset.	x								A low-high-low transition resets the internal SD timing counters		
0x8B	SD Timing Register 1 Note: Applicable in master modes only, that is, Subaddress 0x8A, Bit 0 = 1.	SD HSYNC Width.							0 0 1 1	0 1 0 1	$t_a = 1$ clock cycle $t_a = 4$ clock cycles $t_a = 16$ clock cycles $t_a = 128$ clock cycles	0x00	
		SD HSYNC to VSYNC Delay.					0 0 1 1	0 1 0 1		$t_b = 0$ clock cycles $t_b = 4$ clock cycles $t_b = 8$ clock cycles $t_b = 18$ clock cycles			
		SD HSYNC to VSYNC Rising Edge Delay (Mode 1 Only).			x x	0 1				$t_c = t_b$ $t_c = t_b + 32 \mu s$			
		VSYNC Width (Mode 2 Only).			0 0 1 1	0 1 0 1				1 clock cycle 4 clock cycles 16 clock cycles 128 clock cycles			
		HSYNC to Pixel Data Adjust.	0 0 1 1	0 1 0 1						0 clock cycles 1 clock cycle 2 clock cycles 3 clock cycles			
0x8C	SD F _{sc} Register 0 ¹	Subcarrier Frequency Bits[7:0]	x	x	x	x	x	x	x	x	Subcarrier Frequency Bits[7:0]	0x1F	
0x8D	SD F _{sc} Register 1 ¹	Subcarrier Frequency Bits[15:8]	x	x	x	x	x	x	x	x	Subcarrier Frequency Bits[15:8]	0x7C	
0x8E	SD F _{sc} Register 2 ¹	Subcarrier Frequency Bits[23:16]	x	x	x	x	x	x	x	x	Subcarrier Frequency Bits[23:16]	0xF0	
0x8F	SD F _{sc} Register 3 ¹	Subcarrier Frequency Bits[31:24]	x	x	x	x	x	x	x	x	Subcarrier Frequency Bits[31:24]	0x21	
0x90	SD F _{sc} Phase	Subcarrier Phase Bits[9:2]	x	x	x	x	x	x	x	x	Subcarrier Phase Bits[9:2]	0x00	
0x91	SD Closed Captioning	Extended Data on Even Fields.	x	x	x	x	x	x	x	x	Extended Data Bits[7:0]	0x00	
0x92	SD Closed Captioning	Extended Data on Even Fields.	x	x	x	x	x	x	x	x	Extended Data Bits[15:8].	0x00	
0x93	SD Closed Captioning	Data on Odd Fields.	x	x	x	x	x	x	x	x	Data Bits[7:0]	0x00	
0x94	SD Closed Captioning	Data on Odd Fields.	x	x	x	x	x	x	x	x	Data Bits[15:8]	0x00	
0x95	SD Pedestal Register 0	Pedestal on Odd Fields.	17	16	15	14	13	12	11	10	Setting any of these bits to 1 disables pedestal on the line number indicated by the bit settings	0x00	
0x96	SD Pedestal Register 1	Pedestal on Odd Fields.	25	24	23	22	21	20	19	18		0x00	
0x97	SD Pedestal Register 2	Pedestal on Even Fields.	17	16	15	14	13	12	11	10		0x00	
0x98	SD Pedestal Register 3	Pedestal on Even Fields.	25	24	23	22	21	20	19	18		0x00	

¹ SD subcarrier frequency registers default to NTSC subcarrier frequency values.

ADV7390/ADV7391/ADV7392/ADV7393

Table 27. Register 0x99 to Register 0xA5

SR7 to SRO	Register	Bit Description	Bit Number							Register Setting	Reset Value		
			7	6	5	4	3	2	1			0	
0x99	SD CGMS/WSS 0	SD CGMS Data.					x	x	x	x	CGMS Data Bits[C19:C16]	0x00	
		SD CGMS CRC.				0 1					Disabled Enabled		
		SD CGMS on Odd Fields.			0 1						Disabled Enabled		
		SD CGMS on Even Fields.		0 1							Disabled Enabled		
		SD WSS.	0 1								Disabled Enabled		
0x9A	SD CGMS/WSS 1	SD CGMS/WSS Data.			x	x	x	x	x	x	CGMS Data Bits[C13:C8] or WSS Data Bits[W13:W8]	0x00	
		SD CGMS Data.	x	x							CGMS Data Bits[C15:C14]		
0x9B	SD CGMS/WSS 2	SD CGMS/WSS Data.	x	x	x	x	x	x	x	x	CGMS Data Bits[C7:C0] or WSS Data Bits[W7:W0]	0x00	
0x9C	SD Scale LSB Register	LSBs for SD Y Scale Value.							x	x	SD Y Scale Bits[1:0]	0x00	
		LSBs for SD Cb Scale Value.					x	x			SD Cb Scale Bits[1:0]		
		LSBs for SD Cr Scale Value.			x	x					SD Cr Scale Bits[1:0]		
		LSBs for SD F _{sc} Phase.	x	x							Subcarrier Phase Bits[1:0]		
0x9D	SD Y Scale Register	SD Y Scale Value.	x	x	x	x	x	x	x	x	SD Y Scale Bits[7:2]	0x00	
0x9E	SD Cb Scale Register	SD Cb Scale Value.	x	x	x	x	x	x	x	x	SD Cb Scale Bits[7:2]	0x00	
0x9F	SD Cr Scale Register	SD Cr Scale Value.	x	x	x	x	x	x	x	x	SD Cr Scale Bits[7:2]	0x00	
0xA0	SD Hue Register	SD Hue Adjust Value.	x	x	x	x	x	x	x	x	SD Hue Adjust Bits[7:0]	0x00	
0xA1	SD Brightness/WSS	SD Brightness Value.		x	x	x	x	x	x	x	SD Brightness Bits[6:0]	0x00	
		SD Blank WSS Data.	0 1								Disabled Enabled		
0xA2	SD Luma SSAF	SD Luma SSAF Gain/Attenuation. Note: Only applicable if Subaddress 0x87, Bit 4 = 1.					0	0	0	0	-4 dB	0x00	
								
							0	1	1	0	0		0 dB
						
				1	1	0	0	0	0	+4 dB			
	Reserved.		0	0	0	0							
0xA3	SD DNR 0	Coring Gain Border. Note: In DNR mode, the values in brackets apply.					0	0	0	0	No gain	0x00	
							0	0	0	1	+1/16 [-1/8]		
							0	0	1	0	+2/16 [-2/8]		
							0	0	1	1	+3/16 [-3/8]		
							0	1	0	0	+4/16 [-4/8]		
							0	1	0	1	+5/16 [-5/8]		
							0	1	1	0	+6/16 [-6/8]		
							0	1	1	1	+7/16 [-7/8]		
							1	0	0	0	+8/16 [-1]		
				Coring Gain Data. Note: In DNR mode, the values in brackets apply.	0	0	0	0					
		0	0	0	1					+1/16 [-1/8]			
		0	0	1	0					+2/16 [-2/8]			
		0	0	1	1					+3/16 [-3/8]			
		0	1	0	0					+4/16 [-4/8]			
		0	1	0	1					+5/16 [-5/8]			
		0	1	1	0					+6/16 [-6/8]			
		0	1	1	1					+7/16 [-7/8]			
		1	0	0	0					+8/16 [-1]			

SR7 to SR0	Register	Bit Description	Bit Number								Register Setting	Reset Value		
			7	6	5	4	3	2	1	0				
0xA4	SD DNR 1	DNR Threshold.			0	0	0	0	0	0	0	0	0	0x00
					0	0	0	0	0	0	0	1	1	
				
		Border Area.		0									2 pixels	
		Block Size.	0	1									8 pixels	
			1										16 pixels	
0xA5	SD DNR 2	DNR Input Select.							0	0	1	Filter A	0x00	
									0	1	0	Filter B		
									0	1	1	Filter C		
		DNR Mode.				0						DNR mode		
						1						DNR sharpness mode		
		DNR Block Offset.	0	0	0	0							0 pixel offset	
			0	0	0	1							1 pixel offset	
			
			1	1	1	0							14 pixel offset	
			1	1	1	1							15 pixel offset	

Table 28. Register 0xA6 to Register 0xBB

SR7 to SR0	Register	Bit Description	Bit Number								Register Setting	Reset Value	
			7	6	5	4	3	2	1	0			
0xA6	SD Gamma A0	SD Gamma Curve A (Point 24).	x	x	x	x	x	x	x	x	A0	0x00	
0xA7	SD Gamma A1	SD Gamma Curve A (Point 32).	x	x	x	x	x	x	x	x	A1	0x00	
0xA8	SD Gamma A2	SD Gamma Curve A (Point 48).	x	x	x	x	x	x	x	x	A2	0x00	
0xA9	SD Gamma A3	SD Gamma Curve A (Point 64).	x	x	x	x	x	x	x	x	A3	0x00	
0xAA	SD Gamma A4	SD Gamma Curve A (Point 80).	x	x	x	x	x	x	x	x	A4	0x00	
0xAB	SD Gamma A5	SD Gamma Curve A (Point 96).	x	x	x	x	x	x	x	x	A5	0x00	
0xAC	SD Gamma A6	SD Gamma Curve A (Point 128).	x	x	x	x	x	x	x	x	A6	0x00	
0xAD	SD Gamma A7	SD Gamma Curve A (Point 160).	x	x	x	x	x	x	x	x	A7	0x00	
0xAE	SD Gamma A8	SD Gamma Curve A (Point 192).	x	x	x	x	x	x	x	x	A8	0x00	
0xAF	SD Gamma A9	SD Gamma Curve A (Point 224).	x	x	x	x	x	x	x	x	A9	0x00	
0xB0	SD Gamma B0	SD Gamma Curve B (Point 24).	x	x	x	x	x	x	x	x	B0	0x00	
0xB1	SD Gamma B1	SD Gamma Curve B (Point 32).	x	x	x	x	x	x	x	x	B1	0x00	
0xB2	SD Gamma B2	SD Gamma Curve B (Point 48).	x	X	x	x	x	x	x	x	B2	0x00	
0xB3	SD Gamma B3	SD Gamma Curve B (Point 64).	x	x	x	x	x	x	x	x	B3	0x00	
0xB4	SD Gamma B4	SD Gamma Curve B (Point 80).	x	x	x	x	x	x	x	x	B4	0x00	
0xB5	SD Gamma B5	SD Gamma Curve B (Point 96).	x	x	x	x	x	x	x	x	B5	0x00	
0xB6	SD Gamma B6	SD Gamma Curve B (Point 128).	x	x	x	x	x	x	x	x	B6	0x00	
0xB7	SD Gamma B7	SD Gamma Curve B (Point 160).	x	x	x	x	x	x	x	x	B7	0x00	
0xB8	SD Gamma B8	SD Gamma Curve B (Point 192).	x	x	x	x	x	x	x	x	B8	0x00	
0xB9	SD Gamma B9	SD Gamma Curve B (Point 224).	x	x	x	x	x	x	x	x	B9	0x00	
0xBA	SD Brightness Detect	SD Brightness Value.	x	x	x	x	x	x	x	x	Read only	0xFF	
0xBB	Field Count Register	Field Count.							x	x	x	Read only	0x0X
		Reserved.			0	0	0					Reserved	
		Revision Code.	0	0									Read only

ADV7390/ADV7391/ADV7392/ADV7393

Table 29. Register 0xE0 to Register 0xF1

SR7 to SR0	Register ¹	Bit Description	Bit Number								Register Setting	Reset Value
			7	6	5	4	3	2	1	0		
0xE0	Macrovision	MV Control Bits.	x	x	x	x	x	x	x	x		0x00
0xE1	Macrovision	MV Control Bits.	x	x	x	x	x	x	x	x		0x00
0xE2	Macrovision	MV Control Bits.	x	x	x	x	x	x	x	x		0x00
0xE3	Macrovision	MV Control Bits.	x	x	x	x	x	x	x	x		0x00
0xE4	Macrovision	MV Control Bits.	x	x	x	x	x	x	x	x		0x00
0xE5	Macrovision	MV Control Bits.	x	x	x	x	x	x	x	x		0x00
0xE6	Macrovision	MV Control Bits.	x	x	x	x	x	x	x	x		0x00
0xE7	Macrovision	MV Control Bits.	x	x	x	x	x	x	x	x		0x00
0xE8	Macrovision	MV Control Bits.	x	x	x	x	x	x	x	x		0x00
0xE9	Macrovision	MV Control Bits.	x	x	x	x	x	x	x	x		0x00
0xEA	Macrovision	MV Control Bits.	x	x	x	x	x	x	x	x		0x00
0xEB	Macrovision	MV Control Bits.	x	x	x	x	x	x	x	x		0x00
0xEC	Macrovision	MV Control Bits.	x	x	x	x	x	x	x	x		0x00
0xED	Macrovision	MV Control Bits.	x	x	x	x	x	x	x	x		0x00
0xEE	Macrovision	MV Control Bits.	x	x	x	x	x	x	x	x		0x00
0xEF	Macrovision	MV Control Bits.	x	x	x	x	x	x	x	x		0x00
0xF0	Macrovision	MV Control Bits.	x	x	x	x	x	x	x	x		0x00
0xF1	Macrovision	MV Control Bit.	0	0	0	0	0	0	0	x	Bits[7:1] must be 0	0x00

¹ Macrovision registers are only available on the ADV7390 and the ADV7392.

ADV7390/ADV7391 INPUT CONFIGURATION

The ADV7390/ADV7391 supports a number of different input modes. The desired input mode is selected using Subaddress 0x01, Bits[6:4]. The ADV7390/ADV7391 defaults to standard definition (SD) mode upon power-up. Table 30 provides an overview of all possible input configurations. Each input mode is described in detail in this section.

Table 30. ADV7390/ADV7391 Input Configuration

Input Mode	P7	P6	P5	P4	P2	P2	P1	P0
000 SD				YCrCb				
010 ED/HD-DDR				YCrCb				
111 ED (at 54 MHz)				YCrCb				

STANDARD DEFINITION

Subaddress 0x01, Bits[6:4] = 000

SD YCrCb data can be input in an interleaved 4:2:2 format over an 8-bit bus rate of 27 MHz.

A 27 MHz clock signal must be provided on the CLKIN pin. If required, external synchronization signals can be provided on the HSYNC and VSYNC pins. Embedded EAV/SAV timing codes are also supported. The ITU-R BT.601/656 input standard is supported.

The interleaved pixel data is input on Pin P7 to Pin P0, with P0 being the LSB.

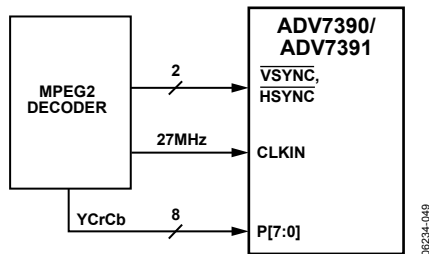

Figure 49. SD Example Application

ENHANCED DEFINITION/HIGH DEFINITION

Subaddress 0x01, Bits[6:4] = 010

ED or HD YCrCb data can be input in an interleaved 4:2:2 format over an 8-bit DDR bus.

The clock signal must be provided on the CLKIN pin. If required, external synchronization signals can be provided on the HSYNC and VSYNC pins. Embedded EAV/SAV timing codes are also supported.

8-Bit 4:2:2 ED/HD YCrCb Mode (DDR)

In 8-bit DDR 4:2:2 YCrCb input mode, the Y pixel data is input on Pin P7 to Pin P0 upon either the rising or falling edge of CLKIN. P0 is the LSB.

The CrCb pixel data is also input on Pin P7 to Pin P0 upon the opposite edge of CLKIN. P0 is the LSB.

Whether the Y data is clocked in upon the rising or falling edge of CLKIN is determined by Subaddress 0x01, Bits[2:1] (see Figure 50 and Figure 51).

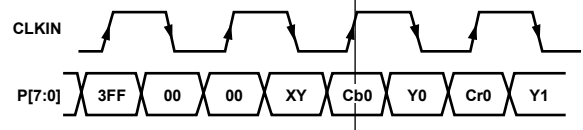

NOTES
1. SUBADDRESS 0x01 [2:1] SHOULD BE SET TO 00 IN THIS CASE.

Figure 50. ED/HD-DDR Input Sequence (EAV/SAV)—Option A

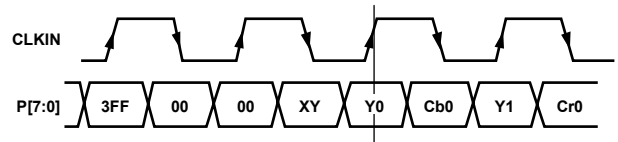

NOTES
1. SUBADDRESS 0x01 [2:1] SHOULD BE SET TO 11 IN THIS CASE.

Figure 51. ED/HD-DDR Input Sequence (EAV/SAV)—Option B

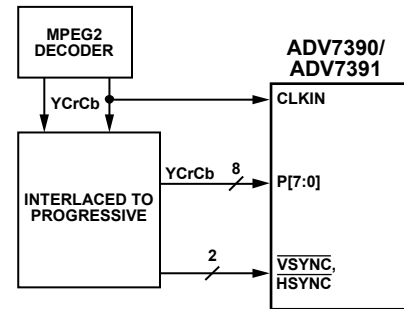

Figure 52. ED/HD-DDR Example Application

ENHANCED DEFINITION (AT 54 MHz)

Subaddress 0x01, Bits[6:4] = 111

ED YCrCb data can be input in an interleaved 4:2:2 format over an 8-bit bus rate of 54 MHz.

A 54 MHz clock signal must be provided on the CLKIN pin. Embedded EAV/SAV timing codes are supported. External synchronization signals are not supported in this mode.

The interleaved pixel data is input on Pin P7 to Pin P0, with P0 being the LSB.



Figure 53. ED (At 54 MHz) Input Sequence (EAV/SAV)

ADV7392/ADV7393 INPUT CONFIGURATION

The ADV7392/ADV7393 supports a number of different input modes. The desired input mode is selected using Subaddress 0x01, Bits[6:4]. The ADV7392/ADV7393 defaults to standard definition (SD) mode upon power-up. Table 31 provides an overview of all possible input configurations. Each input mode is described in detail in this section.

STANDARD DEFINITION

Subaddress 0x01, Bits[6:4] = 000

SD YCrCb data can be input in 4:2:2 format over an 8-, 10-, or 16-bit bus. SD RGB data can be input in 4:4:4 format over a 16-bit bus.

A 27 MHz clock signal must be provided on the CLKIN pin. If required, external synchronization signals can be provided on the HSYNC and VSYNC pins. Embedded EAV/SAV timing codes are also supported in 8-bit and 10-bit modes.

8-Bit 4:2:2 YCrCb Mode

Subaddress 0x87, Bit 7 = 0

Subaddress 0x88, Bits[4:3] = 00

In 8-bit 4:2:2 YCrCb input mode, the interleaved pixel data is input on Pin P15 to Pin P8, with P8 being the LSB. The ITU-R BT.601/656 input standard is supported.

10-Bit 4:2:2 YCrCb Mode

Subaddress 0x87, Bit 7 = 0

Subaddress 0x88, Bits[4:3] = 10

In 10-bit 4:2:2 YCrCb input mode, the interleaved pixel data is input on Pin P15 to Pin P6, with P6 being the LSB. The ITU-R BT.601/656 input standard is supported.

16-Bit 4:2:2 YCrCb Mode

Subaddress 0x87, Bit 7 = 0

Subaddress 0x88, Bits[4:3] = 01

In 16-bit 4:2:2 YCrCb input mode, the Y pixel data is input on Pin P15 to Pin P8, with P8 being the LSB.

The CrCb pixel data is input on Pin P7 to Pin P0, with P0 being the LSB.

The pixel data is updated at half the rate of the clock, that is, at a rate of 13.5 MHz (see Figure 3).

16-Bit 4:4:4 RGB Mode

Subaddress 0x87, Bit 7 = 1

In 16-bit 4:4:4 RGB input mode, the red pixel data is input on Pin P4 to Pin P0, the green pixel data is input on Pin P10 to Pin P5, and the blue pixel data is input on Pin P15 to Pin P11. P0, P5, and P11 are the respective bus LSBs.

The pixel data is updated at half the rate of the clock, that is, at a rate of 13.5 MHz (see Figure 4).

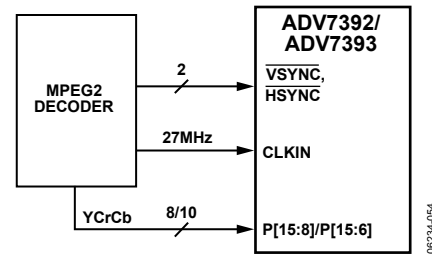

Figure 54. SD Example Application

Table 31. ADV7392/ADV7393 Input Configuration

Input Mode ¹	P15	P14	P13	P12	P11	P10	P9	P8	P7	P6	P5	P4	P3	P2	P1	P0	
000 SD ²	SD RGB Input Enable (0x87[7]) = 0																
	8-Bit	YCrCb															
	10-Bit	YCrCb															
	16-Bit ³	Y							CrCb								
	16-Bit ³	SD RGB Input Enable (0x87[7]) = 1															
	B					G					R						
001 ED/HD-SDR (16-Bit)	Y							CrCb									
010 ED/HD-DDR ⁴	ED/HD Input Format (0x33[2]) = 0																
	8-Bit	YCrCb															
	ED/HD Input Format (0x33[2]) = 1																
	YCrCb																
111 ED (At 54 MHz)	ED/HD Input Format (0x33[2]) = 0																
	8-Bit	YCrCb															
		ED/HD Input Format (0x33[2]) = 1															
	YCrCb																

¹ The input mode is determined by Subaddress 0x01, Bits[6:4].

² In SD mode, the width of the input data is determined by Subaddress 0x88, Bits[4:3].

³ External synchronization signals must be used in this input mode. Embedded EAV/SAV timing codes are not supported.

⁴ ED = enhanced definition = 525p and 625p.

ENHANCED DEFINITION/HIGH DEFINITION

Subaddress 0x01, Bits[6:4] = 001 or 010

ED or HD YCrCb data can be input in a 4:2:2 format over an 8-/10-bit DDR bus or a 16-bit SDR bus.

The clock signal must be provided on the CLKIN pin. If required, external synchronization signals can be provided on the $\overline{\text{HSYNC}}$ and $\overline{\text{VSYNC}}$ pins. Embedded EAV/SAV timing codes are also supported.

16-Bit 4:2:2 YCrCb Mode (SDR)

In 16-bit 4:2:2 YCrCb input mode, the Y pixel data is input on Pin P15 to Pin P8, with P8 being the LSB.

The CrCb pixel data is input on Pin P7 to Pin P0, with P0 being the LSB.

8-/10-Bit 4:2:2 YCrCb Mode (DDR)

In 8-/10-bit DDR 4:2:2 YCrCb input mode, the Y pixel data is input on Pin P15 to Pin P8/P6 upon either the rising or falling edge of CLKIN. P8/P6 is the LSB.

The CrCb pixel data is also input on Pin P15 to Pin P8/P6 upon the opposite edge of CLKIN. P8/P6 is the LSB.

10-bit mode is enabled using Subaddress 0x33, Bit 2. Whether the Y data is clocked in upon the rising or falling edge of CLKIN is determined by Subaddress 0x01, Bits[2:1] (see Figure 55 and Figure 56).

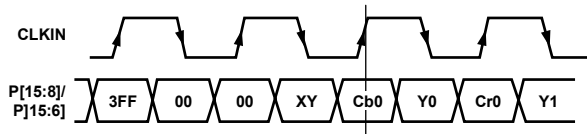

- NOTES
 1. SUBADDRESS 0x01 [2:1] SHOULD BE SET TO 00 IN THIS CASE.
 2. 10-BIT MODE IS ENABLED USING SUBADDRESS 0x33, BIT 2.

Figure 55. ED/HD-DDR Input Sequence (EAV/SAV)—Option A

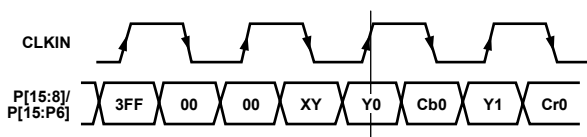

- NOTES
 1. SUBADDRESS 0x01 [2:1] SHOULD BE SET TO 11 IN THIS CASE.
 2. 10-BIT MODE IS ENABLED USING SUBADDRESS 0x33, BIT 2.

Figure 56. ED/HD-DDR Input Sequence (EAV/SAV)—Option B

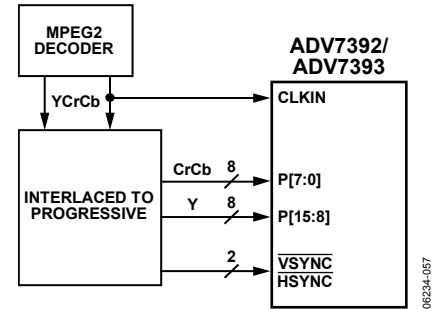

Figure 57. ED/HD-SDR Example Application

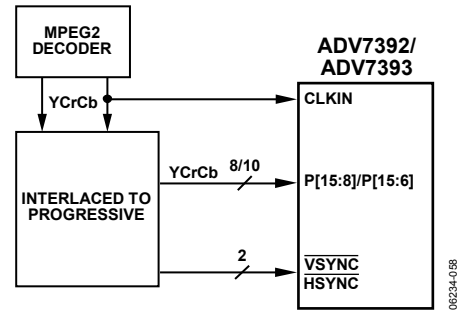

Figure 58. ED/HD-DDR Example Application

ENHANCED DEFINITION (AT 54 MHz)

Subaddress 0x01, Bits[6:4] = 111

ED YCrCb data can be input in an interleaved 4:2:2 format on an 8-/10-bit bus at a rate of 54 MHz.

A 54 MHz clock signal must be provided on the CLKIN pin. Embedded EAV/SAV timing codes are supported. External synchronization signals are not supported in this mode.

The interleaved pixel data is input on Pin P15 to Pin P8/P6, with P8/P6 being the LSB.

10-bit mode is enabled using Subaddress 0x33, Bit 2.

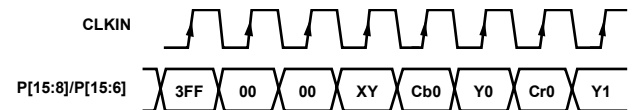

- NOTES
 1. 10-BIT MODE IS ENABLED USING SUBADDRESS 0x33, BIT 2.

Figure 59. ED (At 54 MHz) Input Sequence (EAV/SAV)

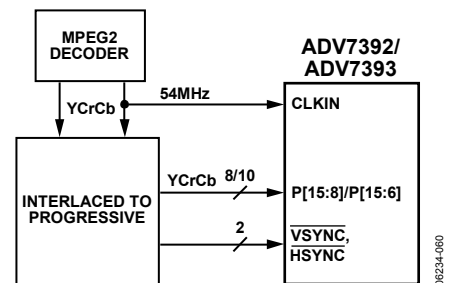

Figure 60. ED (At 54 MHz) Example Application

ADV7390/ADV7391/ADV7392/ADV7393

OUTPUT CONFIGURATION

The ADV739x supports a number of different output configurations. Table 32 to Table 34 lists all possible output configurations.

Table 32. SD Output Configurations

RGB/YPrPb Output Select ¹ (0x02, Bit 5)	SD DAC Output 1 (0x82, Bit 1)	SD Luma/Chroma Swap (0x84, Bit 7)	DAC 1	DAC 2	DAC 3
0	0	0	G	B	R
1	0	0	Y	Pb	Pr
1	1	0	CVBS	Luma	Chroma
1	1	1	CVBS	Chroma	Luma

¹ If SD RGB output is selected, a color reversal is possible using Subaddress 0x86, Bit 7.

Table 33. ED/HD Output Configurations

RGB/YPrPb Output Select (0x02, Bit 5)	ED/HD Color DAC Swap (0x35, Bit 3)	DAC 1	DAC 2	DAC 3
0	0	G	B	R
0	1	G	R	B
1	0	Y	Pb	Pr
1	1	Y	Pr	Pb

Table 34. ED (at 54 MHz) Output Configurations

RGB/YPrPb Output Select (0x02, Bit 5)	ED/HD Color DAC Swap (0x35, Bit 3)	DAC 1	DAC 2	DAC 3
0	0	G	B	R
0	1	G	R	B
1	0	Y	Pb	Pr
1	1	Y	Pr	Pb

FEATURES

OUTPUT OVERSAMPLING

The ADV739x include an on-chip phase-locked loop (PLL) that allows for oversampling of SD, ED, and HD video data. By default, the PLL is disabled. The PLL can be enabled using Subaddress 0x00, Bit 1 = 0.

Table 35 shows the various oversampling rates supported in the ADV739x.

ED/HD NONSTANDARD TIMING MODE

Subaddress 0x30, Bits[7:3] = 00001

For any ED/HD input data that does not conform to the standards listed in the ED/HD input mode table (Subaddress 0x30, Bits[7:3]), the ED/HD nonstandard timing mode can be used to interface to the ADV739x. ED/HD nonstandard timing mode can be enabled by setting Subaddress 0x30, Bits[7:3] to 00001.

A clock signal must be provided on the CLKIN pin. $\overline{\text{HSYNC}}$ and $\overline{\text{VSYNC}}$ must be toggled by the user to generate the appropriate horizontal and vertical synchronization pulses on the analog output from the encoder. Figure 61 illustrates the

various output levels that can be generated. Table 36 lists the transitions required to generate the various output levels.

Embedded EAV/SAV timing codes are not supported in ED/HD nonstandard timing mode.

The user must ensure that appropriate pixel data is applied to the encoder where the blanking level is expected at the output.

Macrovision (ADV7390/ADV7392 only) and output oversampling are not available in ED/HD nonstandard timing mode. The PLL must be disabled (Subaddress 0x00, Bit 1 = 1) in ED/HD nonstandard timing mode.

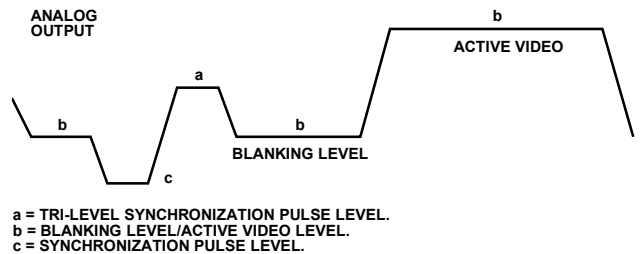

Figure 61. ED/HD Nonstandard Timing Mode Output Levels

Table 35. Output Oversampling Modes and Rates

Input Mode (0x01, Bits[6:4])	PLL and Oversampling Control (0x00, Bit 1)	SD/ED Oversample Rate Select (0x0D, Bit 3)	HD Oversample Rate Select (0x31, Bit 1)	Oversampling Mode and Rate
000	SD	1	x	SD (2x)
000	SD	0	1	SD (8x)
000	SD	0	0	SD (16x)
001/010	ED	1	x	ED (1x)
001/010	ED	0	1	ED (4x)
001/010	ED	0	0	ED (8x)
001/010	HD	1	x	HD (1x)
001/010	HD	0	1	HD (2x)
001/010	HD	0	0	HD (4x)
111	ED (at 54 MHz)	1	x	ED (@ 54 MHz) (1x)
111	ED (at 54 MHz)	0	1	ED (@ 54 MHz) (4x)
111	ED (at 54 MHz)	0	0	ED (@ 54 MHz) (8x)

Table 36. ED/HD Nonstandard Timing Mode Synchronization Signal Generation

Output Level Transition ¹	$\overline{\text{HSYNC}}$	$\overline{\text{VSYNC}}$
b → c	1 → 0	1 → 0 or 0 ²
c → a	0	0 → 1
a → b	0 → 1	1
c → b	0 → 1	0

¹ a = Tri-level synchronization pulse level; b = blanking level/active video level; c = synchronization pulse level. See Figure 61.

² If $\overline{\text{VSYNC}} = 1$, it should transition to 0. If $\overline{\text{VSYNC}} = 0$, it should remain at 0. If tri-level synchronization pulse generation is not required, $\overline{\text{VSYNC}}$ should always be 0.

ED/HD TIMING RESET

Subaddress 0x34, Bit 0

An ED/HD timing reset is achieved by setting the ED/HD timing reset control bit (Subaddress 0x34, Bit 0) to 1. In this state, the horizontal and vertical counters remain reset. When this bit is set back to 0, the internal counters resume counting. This timing reset applies to the ED/HD timing counters only.

SD SUBCARRIER FREQUENCY LOCK, SUBCARRIER RESET, AND TIMING RESET

Subaddress 0x84, Bits[2:1]

Together with the SFL/MISO pin and SD Mode Register 4 (Subaddress 0x84, Bits[2:1]), the ADV739x can be used in timing reset mode, subcarrier phase reset mode, or SFL mode.

- In timing reset (TR) mode (Subaddress 0x84, Bits[2:1] = 10), a timing reset is achieved in a low-to-high transition on the SFL/MISO pin. In this state, the horizontal and vertical counters remain reset. Upon releasing this pin (set to low), the internal counters resume counting, starting with Field 1, and the subcarrier phase is reset.

The minimum time the pin must be held high is one clock cycle; otherwise, this reset signal may not be recognized. This timing reset applies to the SD timing counters only.

- In subcarrier reset (SCR) mode (Subaddress 0x84, Bits[2:1] = 01), a low-to-high transition on the SFL/MISO pin resets the subcarrier phase to 0 on the field following the subcarrier phase reset.

This reset signal must be held high for a minimum of one clock cycle.

Because the field counter is not reset, it is recommended to apply the reset signal in Field 7 (PAL) or Field 3 (NTSC). The reset of the phase then occurs on the next field, that is, Field 1, which is lined up correctly with the internal counters. The field count register at Subaddress 0xBB can be used to identify the number of the active field.

- In subcarrier frequency lock (SFL) mode (Subaddress 0x84, Bits[2:1] = 11), the ADV739x can be used to lock to an external video source. The SFL mode allows the ADV739x to automatically alter the subcarrier frequency to compensate for line length variations. When the part is connected to a device such as an ADV7403 video decoder that outputs a digital data stream in the SFL format, the part automatically changes to the compensated subcarrier frequency on a line-by-line basis (see Figure 64). This digital data stream is 67 bits wide and the subcarrier is contained in Bit 0 to Bit 21. Each bit is two clock cycles long.

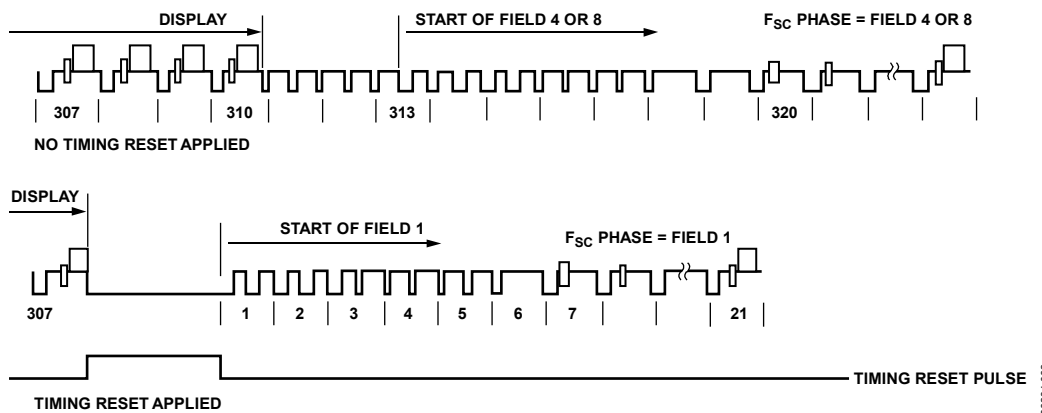

Figure 62. SD Timing Reset Timing Diagram (Subaddress 0x84, Bits [2:1] = 10)

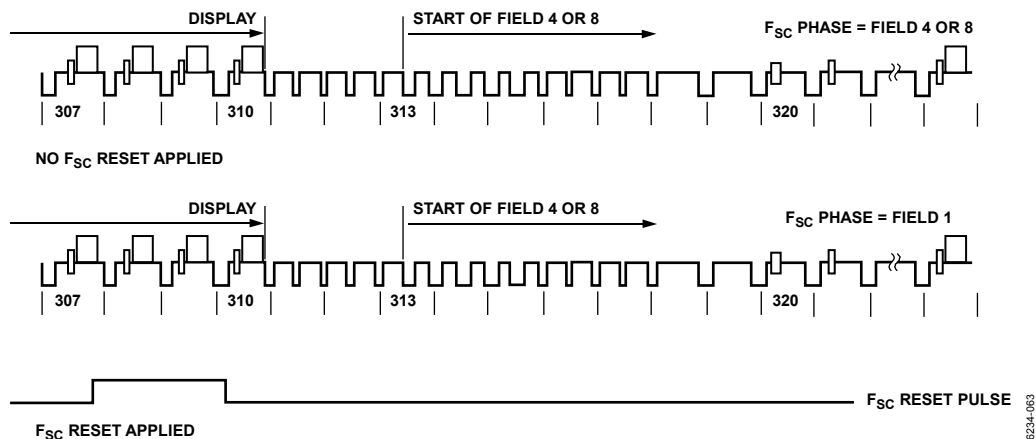

Figure 63. SD Subcarrier Phase Reset Timing Diagram (Subaddress 0x84, Bits [2:1] = 01)

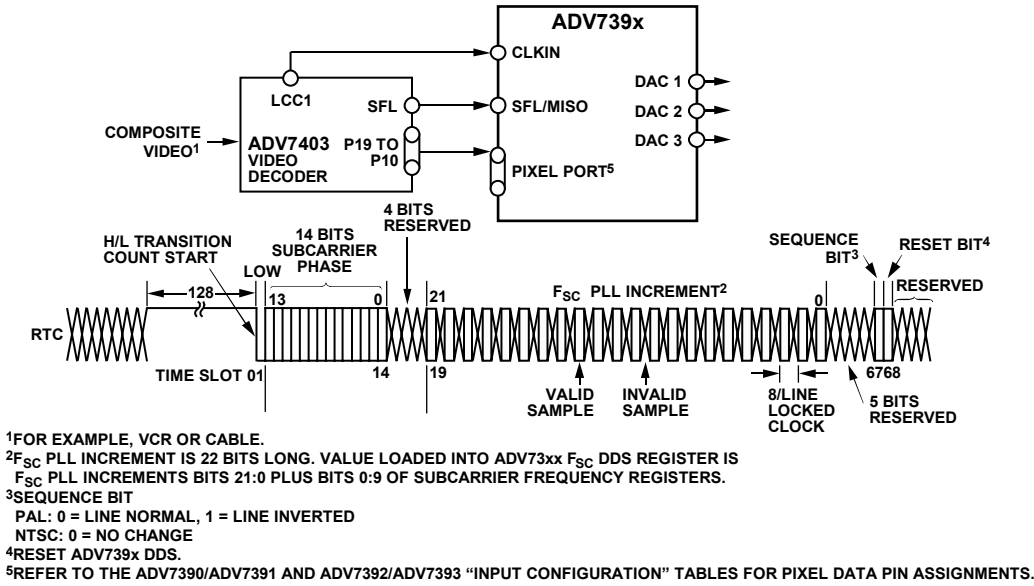

Figure 64. SD Subcarrier Frequency Lock Timing and Connections Diagram (Subaddress 0x84, Bits [2:1] = 11)

06234-1064

SD VCR FF/RW SYNC

Subaddress 0x82, Bit 5

In DVD record applications where the encoder is used with a decoder, the VCR FF/RW sync control bit can be used for non-standard input video, that is, in fast forward or rewind modes.

In fast forward mode, the sync information at the start of a new field in the incoming video usually occurs before the correct number of lines/fields is reached. In rewind mode, this sync signal usually occurs after the total number of lines/fields is reached. Conventionally, this means that the output video has corrupted field signals because one signal is generated by the incoming video and another is generated when the internal line/field counters reach the end of a field.

When the VCR FF/RW sync control is enabled (Subaddress 0x82, Bit 5), the line/field counters are updated according to the incoming VSYNC signal and when the analog output matches the incoming VSYNC signal.

This control is available in all slave-timing modes except Slave Mode 0.

VERTICAL BLANKING INTERVAL

Subaddress 0x31, Bit 4; Subaddress 0x83, Bit 4

The ADV739x is able to accept input data that contains vertical blanking interval (VBI) data (such as CGMS, WSS, VITS) in SD, ED, and HD modes.

If VBI is disabled (Subaddress 0x31, Bit 4 for ED/HD; Subaddress 0x83, Bit 4 for SD), VBI data is not present at the output and the entire VBI is blanked. These control bits are valid in all master and slave timing modes.

For the SMPTE 293M (525p) standard, VBI data can be inserted on Line 13 to Line 42 of each frame, or on Line 6 to Line 43 for the ITU-R BT.1358 (625p) standard.

VBI data can be present on Line 10 to Line 20 for NTSC and on Line 7 to Line 22 for PAL.

In SD Timing Mode 0 (slave option), if VBI is enabled, the blanking bit in the EAV/SAV code is overwritten. It is possible to use VBI in this timing mode as well.

If CGMS is enabled and VBI is disabled, the CGMS data is nevertheless available at the output.

SD SUBCARRIER FREQUENCY REGISTERS

Subaddress 0x8C to Subaddress 0x8F

Four 8-bit registers are used to set up the subcarrier frequency. The value of these registers is calculated using the following equation:

$$\text{Subcarrier Frequency Register} = \frac{\text{Number of subcarrier periods in one video line}}{\text{Number of 27 MHz clock cycles in one video line}} \times 2^{32}$$

where the sum is rounded to the nearest integer.

For example, in NTSC mode:

$$\text{Subcarrier Register Value} = \left(\frac{227.5}{1716} \right) \times 2^{32} = 569408543$$

where:

$$\text{Subcarrier Register Value} = 569408543_{10} = 0 \times 21 \text{F}07\text{C}1\text{F}_{16}$$

SD F_{SC} Register 0: 0x1F

SD F_{SC} Register 1: 0x7C

SD F_{SC} Register 2: 0xF0

SD F_{SC} Register 3: 0x21

ADV7390/ADV7391/ADV7392/ADV7393

Programming the F_{sc}

The subcarrier frequency register value is divided into four F_{sc} registers as shown in the previous example. The four subcarrier frequency registers must be updated sequentially, starting with Subcarrier Frequency Register 0 and ending with Subcarrier Frequency Register 3. The subcarrier frequency updates only after the last subcarrier frequency register byte has been received by the ADV739x.

Typical F_{sc} Values

Table 37 outlines the values that should be written to the subcarrier frequency registers for NTSC and PAL B/D/G/H/I.

Table 37. Typical F_{sc} Values

Subaddress	Description	NTSC	PAL B/D/G/H/I
0x8C	F_{sc0}	0x1F	0xCB
0x8D	F_{sc1}	0x7C	0x8A
0x8E	F_{sc2}	0xF0	0x09
0x8F	F_{sc3}	0x21	0x2A

SD NONINTERLACED MODE

Subaddress 0x88, Bit 1

The ADV739x supports a SD noninterlaced mode. Using this mode, progressive inputs at twice the frame rate of NTSC and PAL (240p/59.94 Hz and 288p/50 Hz, respectively) can be input into the ADV739x. The SD noninterlaced mode can be enabled using Subaddress 0x88, Bit 1.

A 27 MHz clock signal must be provided on the CLKIN pin. Embedded EAV/SAV timing codes or external horizontal and vertical synchronization signals provided on the \overline{HSYNC} and \overline{VSYNC} pins can be used to synchronize the input pixel data.

All input configurations, output configurations, and features available in NTSC and PAL modes are available in SD noninterlaced mode.

For 240p/59.94 Hz input, the ADV739x should be configured for NTSC operation and Subaddress 0x88, Bit 1 should be set to 1.

For 288p/50 Hz input, the ADV739x should be configured for PAL operation and Subaddress 0x88, Bit 1 should be set to 1.

SD SQUARE PIXEL MODE

Subaddress 0x82, Bit 4

The ADV739x can be used to operate in square pixel mode (Subaddress 0x82, Bit 4). For NTSC operation, an input clock of 24.5454 MHz is required. Alternatively, for PAL operation, an input clock of 29.5 MHz is required. The internal timing logic adjusts accordingly for square pixel mode operation.

In square pixel mode, the timing diagrams shown in Figure 65 and Figure 66 apply.

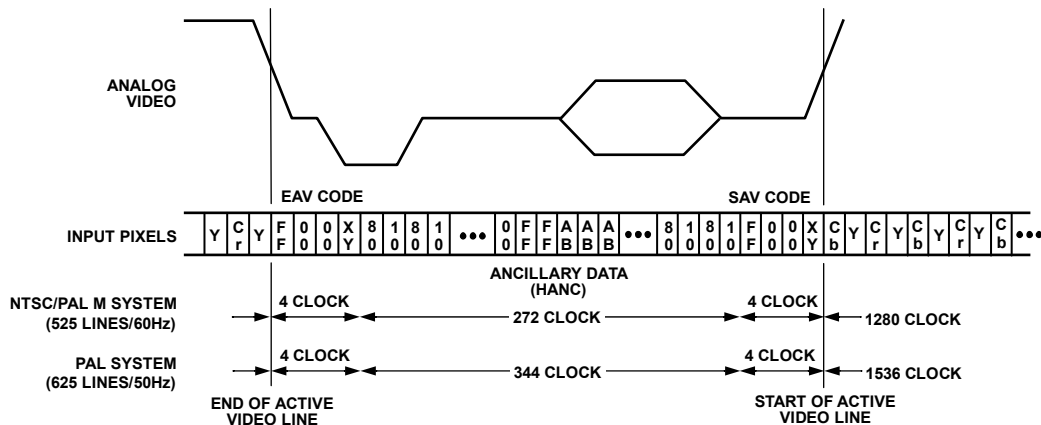

Figure 65. Square Pixel Mode EAV/SAV Embedded Timing

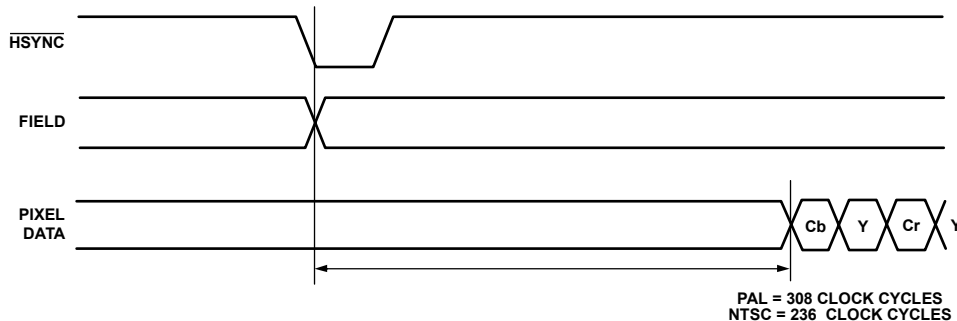

Figure 66. Square Pixel Mode Active Pixel Timing

FILTERS

Table 38 shows an overview of the programmable filters available on the ADV739x.

Table 38. Selectable Filters

Filter	Subaddress
SD Luma LPF NTSC	0x80
SD Luma LPF PAL	0x80
SD Luma Notch NTSC	0x80
SD Luma Notch PAL	0x80
SD Luma SSAF	0x80
SD Luma CIF	0x80
SD Luma QCIF	0x80
SD Chroma 0.65 MHz	0x80
SD Chroma 1.0 MHz	0x80
SD Chroma 1.3 MHz	0x80
SD Chroma 2.0 MHz	0x80
SD Chroma 3.0 MHz	0x80
SD Chroma CIF	0x80
SD Chroma QCIF	0x80
SD PrPb SSAF	0x82
ED/HD Sinc Compensation Filter	0x33
ED/HD Chroma SSAF	0x33

SD Internal Filter Response

Subaddress 0x80, Bits[7:2]; Subaddress 0x82, Bit 0

The Y filter supports several different frequency responses, including two low-pass responses, two notch responses, an extended (SSAF) response with or without gain boost attenuation, a CIF response, and a QCIF response. The PrPb filter supports several different frequency responses, including six low-pass responses, a CIF response, and a QCIF response, as shown in Figure 36 and Figure 37.

If SD Luma SSAF gain is enabled (Subaddress 0x87, Bit 4), there are 13 response options in the range -4 dB to +4 dB. The desired response can be programmed using Subaddress 0xA2. The variation of frequency responses are shown in Figure 33 to Figure 35.

In addition to the chroma filters listed in Table 38, the ADV739x contains an SSAF filter specifically designed for the color difference component outputs, Pr and Pb. This filter has a cutoff frequency of ~2.7 MHz and a gain of -40 dB at 3.8 MHz (see Figure 67). This filter can be controlled with Subaddress 0x82, Bit 0.

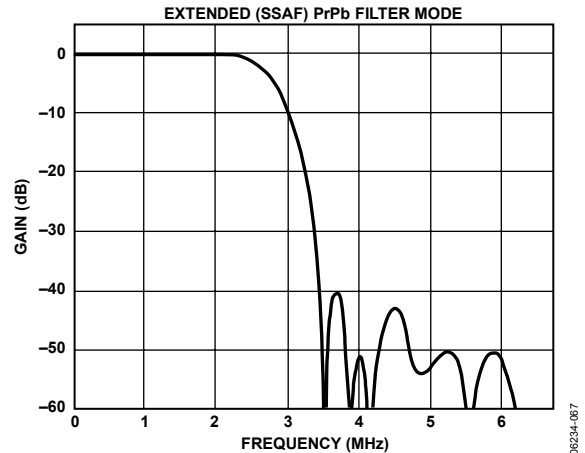

Figure 67. PrPb SSAF Filter

If this filter is disabled, one of the chroma filters shown in Table 39 can be selected and used for the CVBS or luma/ chroma signal.

Table 39. Internal Filter Specifications

Filter	Pass-Band Ripple (dB) ¹	3 dB Bandwidth (MHz) ²
Luma LPF NTSC	0.16	4.24
Luma LPF PAL	0.1	4.81
Luma Notch NTSC	0.09	2.3/4.9/6.6
Luma Notch PAL	0.1	3.1/5.6/6.4
Luma SSAF	0.04	6.45
Luma CIF	0.127	3.02
Luma QCIF	Monotonic	1.5
Chroma 0.65 MHz	Monotonic	0.65
Chroma 1.0 MHz	Monotonic	1
Chroma 1.3 MHz	0.09	1.395
Chroma 2.0 MHz	0.048	2.2
Chroma 3.0 MHz	Monotonic	3.2
Chroma CIF	Monotonic	0.65
Chroma QCIF	Monotonic	0.5

¹ Pass-band ripple is the maximum fluctuation from the 0 dB response in the pass band, measured in dB. The pass band is defined to have 0 Hz to f_c (Hz) frequency limits for a low-pass filter, and 0 Hz to f_1 (Hz) and f_2 (Hz) to infinity for a notch filter, where f_c , f_1 , and f_2 are the -3 dB points.

² 3 dB bandwidth refers to the -3 dB cutoff frequency.

ADV7390/ADV7391/ADV7392/ADV7393

ED/HD Sinc Compensation Filter Response

Subaddress 0x33, Bit 3

The ADV739x includes a filter designed to counter the effect of sinc roll-off in DAC 1, DAC 2, and DAC 3 while operating in ED/HD mode. This filter is enabled by default. It can be disabled using Subaddress 0x33, Bit 3. The benefit of the filter is illustrated in Figure 68 and Figure 69.

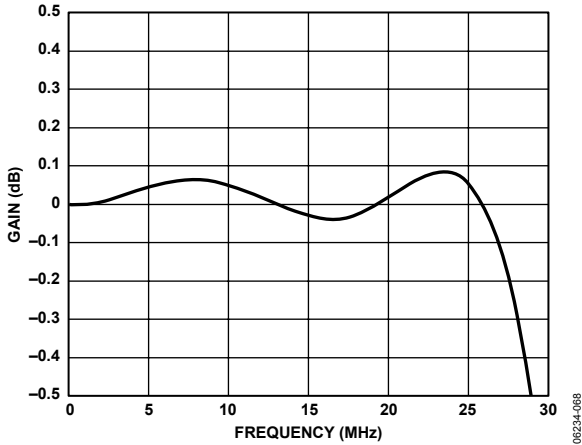

Figure 68. ED/HD Sinc Compensation Filter Enabled

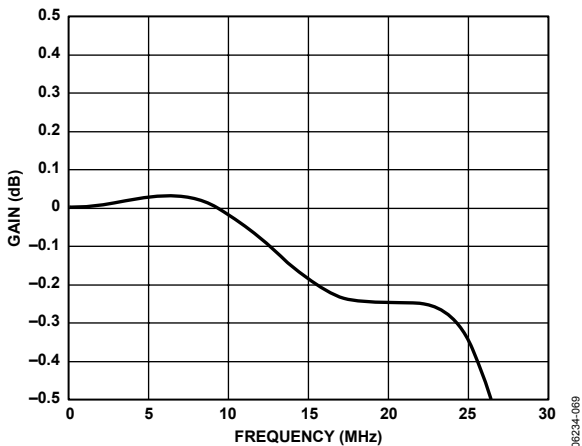

Figure 69. ED/HD Sinc Compensation Filter Disabled

ED/HD TEST PATTERN COLOR CONTROLS

Subaddress 0x36 to Subaddress 0x38

Three 8-bit registers at Subaddress 0x36 to Subaddress 0x38 are used to program the output color of the internal ED/HD test pattern generator (Subaddress 0x31, Bit 2 = 1), whether it be the lines of the cross hatch pattern or the uniform field test pattern. They are not functional as color controls for external pixel data input.

The values for the luma (Y) and color difference (Cr and Cb) signals used to obtain white, black, and saturated primary and complementary colors conform to the ITU-R BT.601-4 standard.

Table 40 shows sample color values that can be programmed into the color registers when the output standard selection is set to EIA770.2/EIA770.3 (Subaddress 0x30, Bits[1:0] = 00).

Table 40. Sample Color Values for EIA770.2/EIA770.3 ED/HD Output Standard Selection

Sample Color	Y Value	Cr Value	Cb Value
White	235 (0xEB)	128 (0x80)	128 (0x80)
Black	16 (0x10)	128 (0x80)	128 (0x80)
Red	81 (0x51)	240 (0xF0)	90 (0x5A)
Green	145 (0x91)	34 (0x22)	54 (0x36)
Blue	41 (0x29)	110 (0x6E)	240 (0xF0)
Yellow	210 (0xD2)	146 (0x92)	16 (0x10)
Cyan	170 (0xAA)	16 (0x10)	166 (0xA6)
Magenta	106 (0x6A)	222 (0xDE)	202 (0xCA)

COLOR SPACE CONVERSION MATRIX

Subaddress 0x03 to Subaddress 0x09

The internal color space conversion (CSC) matrix automatically performs all color space conversions based on the input mode programmed in the mode select register (Subaddress 0x01, Bits[6:4]). Table 41 and Table 42 show the options available in this matrix.

An SD color space conversion from RGB-in to YPrPb-out is possible on the ADV7392/ADV7393. An ED/HD color space conversion from RGB-in to YPrPb-out is not possible.

Table 41. SD Color Space Conversion Options

Input	Output ¹	YPrPb/RGB Out (Reg. 0x02, Bit 5)	RGB In/YCrCb In (Reg. 0x87, Bit 7)
YCrCb	YPrPb	1	0
YCrCb	RGB	0	0
RGB ²	YPrPb	1	1
RGB ²	RGB	0	1

¹ CVBS/YC outputs are available for all CSC combinations.

² Available on the ADV7392/ADV7393 (40-pin devices) only.

Table 42. ED/HD Color Space Conversion Options

Input	Output	YPrPb/RGB Out (Reg. 0x02, Bit 5)
YCrCb	YPrPb	1
YCrCb	RGB	0

ED/HD Manual CSC Matrix Adjust Feature

The ED/HD manual CSC matrix adjust feature provides custom coefficient manipulation for color space conversions and is used in ED and HD modes only. The ED/HD manual CSC matrix adjust feature can be enabled using Subaddress 0x02, Bit 3.

Normally, there is no need to enable this feature because the CSC matrix automatically performs the color space conversion based on the input mode chosen (ED or HD) and the output color space selected (see Table 42). For this reason, the ED/HD manual CSC matrix adjust feature is disabled by default.

If RGB output is selected, the ED/HD CSC matrix scalar uses the following equations:

$$R = GY \times Y + RV \times Pr$$

$$G = GY \times Y - (GU \times Pb) - (GV \times Pr)$$

$$B = GY \times Y + BU \times Pb$$

Note that subtractions are implemented in hardware.

If YPrPb output is selected, the following equations are used:

$$Y = GY \times Y$$

$$Pr = RV \times Pr$$

$$Pb = BU \times Pb$$

where:

GY = Subaddress 0x05, Bits[7:0] and Subaddress 0x03, Bits[1:0].

GU = Subaddress 0x06, Bits[7:0] and Subaddress 0x04, Bits[7:6].

GV = Subaddress 0x07, Bits[7:0] and Subaddress 0x04, Bits[5:4].

BU = Subaddress 0x08, Bits[7:0] and Subaddress 0x04, Bits[3:2].

RV = Subaddress 0x09, Bits[7:0] and Subaddress 0x04, Bits[1:0].

Upon power-up, the CSC matrix is programmed with the default values shown in Table 43.

Table 43. ED/HD Manual CSC Matrix Default Values

Subaddress	Default
0x03	0x03
0x04	0xF0
0x05	0x4E
0x06	0x0E
0x07	0x24
0x08	0x92
0x09	0x7C

When the ED/HD manual CSC matrix adjust feature is enabled, the default coefficient values in Subaddress 0x03 to Subaddress 0x09 are correct for the HD color space only. The color components are converted according to the following 1080i and 720p standards (SMPTE 274M, SMPTE 296M):

$$R = Y + 1.575Pr$$

$$G = Y - 0.468Pr - 0.187Pb$$

$$B = Y + 1.855Pb$$

The conversion coefficients should be multiplied by 315 before being written to the ED/HD CSC matrix registers. This is reflected in the default values for $GY = 0x13B$, $GU = 0x03B$, $GV = 0x093$, $BU = 0x248$, and $RV = 0x1F0$.

If the ED/HD manual CSC matrix adjust feature is enabled and another input standard (such as ED) is used, the scale values for GY , GU , GV , BU , and RV must be adjusted according to this input standard color space. The user should consider that the color component conversion might use different scale values.

For example, SMPTE 293M uses the following conversion:

$$R = Y + 1.402Pr$$

$$G = Y - 0.714Pr - 0.344Pb$$

$$B = Y + 1.773Pb$$

The programmable CSC matrix is used for external ED/HD pixel data and is not functional when internal test patterns are enabled.

Programming the CSC Matrix

If custom manipulation of the ED/HD CSC matrix coefficients is required for a YCrCb-to-RGB color space conversion, follow the following procedure:

1. Enable the ED/HD manual CSC matrix adjust feature (Subaddress 0x02, Bit 3).
2. Set the output to RGB (Subaddress 0x02, Bit 5).
3. Disable sync on PrPb (Subaddress 0x35, Bit 2).
4. Enable sync on RGB (optional) (Subaddress 0x02, Bit 4).

The GY value controls the green signal output level, the BU value controls the blue signal output level, and the RV value controls the red signal output level.

SD LUMA AND COLOR CONTROL

Subaddress 0x9C to Subaddress 0x9F

SD Y Scale, SD Cb Scale, and SD Cr Scale are three 10-bit control registers that scale the SD Y, Cb, and Cr output levels.

Each of these registers represent the value required to scale the Cb or Cr level from 0.0 to 2.0 and the Y level from 0.0 to 1.5 times its initial level. The value of these 10 bits is calculated using the following equation:

$$Y, Cb, \text{ or } Cr \text{ Scale Value} = \text{Scale Factor} \times 512$$

For example, if $\text{Scale Factor} = 1.3$

$$Y, Cb, \text{ or } Cr \text{ Scale Value} = 1.3 \times 512 = 665.6$$

$$Y, Cb, \text{ or } Cr \text{ Scale Value} = 666 \text{ (rounded to the nearest integer)}$$

$$Y, Cb, \text{ or } Cr \text{ Scale Value} = 1010 \ 0110 \ 10b$$

Subaddress 0x9C, SD Scale LSB Register = 0x2A

Subaddress 0x9D, SD Y Scale Register = 0xA6

Subaddress 0x9E, SD Cb Scale Register = 0xA6

Subaddress 0x9F, SD Cr Scale Register = 0xA6

Note that this feature affects all interlaced output signals, that is, CVBS, Y-C, YPrPb, and RGB.

ADV7390/ADV7391/ADV7392/ADV7393

SD HUE ADJUST CONTROL

Subaddress 0xA0

When enabled, the SD hue adjust control register (Subaddress 0xA0) is used to adjust the hue on the SD composite and chroma outputs. This feature can be enabled using Subaddress 0x87, Bit 2.

Subaddress 0xA0 contains the bits required to vary the hue of the video data, that is, the variance in phase of the subcarrier during active video with respect to the phase of the subcarrier during the color burst. The ADV739x provides a range of $\pm 22.5^\circ$ in increments of 0.17578125° . For normal operation (zero adjustment), this register is set to 0x80. Values 0xFF and 0x00 represent the upper and lower limits, respectively, of the attainable adjustment in NTSC mode. Values 0xFF and 0x01 represent the upper and lower limits, respectively, of the attainable adjustment in PAL mode.

The hue adjust value is calculated using the following equation:

$$\text{Hue Adjust } (^\circ) = 0.17578125^\circ (HCR_d - 128)$$

where = HCR_d hue adjust control register (decimal)

For example, to adjust the hue by $+4^\circ$, write 0x97 to the hue adjust control register:

$$\left(\frac{4}{0.17578125} \right) + 128 \approx 151d = 0x97$$

where the sum is rounded to the nearest integer.

To adjust the hue by -4° , write 0x69 to the hue adjust control register:

$$\left(\frac{-4}{0.17578125} \right) + 128 \approx 105d = 0x69$$

where the sum is rounded to the nearest integer.

SD BRIGHTNESS DETECT

Subaddress 0xBA

The ADV739x allows monitoring of the brightness level of the incoming video data. The SD brightness detect register (Subaddress 0xBA) is a read-only register.

SD BRIGHTNESS CONTROL

Subaddress 0xA1, Bits[6:0]

When this feature is enabled, the SD brightness/WSS control register (Subaddress 0xA1) is used to control brightness by adding a programmable setup level onto the scaled Y data. This feature can be enabled using Subaddress 0x87, Bit 3.

For NTSC with pedestal, the setup can vary from 0 IRE to 22.5 IRE. For NTSC without pedestal (see Figure 70) and for PAL, the setup can vary from -7.5 IRE to $+15$ IRE.

The SD brightness control register is an 8-bit register. The seven LSBs of this 8-bit register are used to control the brightness level, which can be a positive or negative value.

For example,

To add $+20$ IRE brightness level to an NTSC signal with pedestal, write 0x28 to Subaddress 0xA1.

$$\begin{aligned} 0 \times (\text{SD Brightness Value}) &= \\ 0 \times (\text{IRE Value} \times 2.015631) &= \\ 0 \times (20 \times 2.015631) &= 0 \times (40.31262) \approx 0x28 \end{aligned}$$

To add -7 IRE brightness level to a PAL signal, write 0x72 to Subaddress 0xA1.

$$\begin{aligned} 0 \times (\text{SD Brightness Value}) &= \\ 0 \times (\text{IRE Value} \times 2.075631) &= \\ 0 \times (7 \times 2.075631) &= 0x(14.109417) \approx 0001110b \\ 0001110b \text{ into two's complement} &= 1110010b = 0x72 \end{aligned}$$

Table 44. Sample Brightness Control Values¹

Setup Level (NTSC) with Pedestal	Setup Level (NTSC) Without Pedestal	Setup Level (PAL)	Brightness Control Value
22.5 IRE	15 IRE	15 IRE	0x1E
15 IRE	7.5 IRE	7.5 IRE	0x0F
7.5 IRE	0 IRE	0 IRE	0x00
0 IRE	-7.5 IRE	-7.5 IRE	0x71

¹ Values in the range of 0x3F to 0x44 can result in an invalid output signal.

SD INPUT STANDARD AUTO DETECTION

Subaddress 0x87, Bit 5

The ADV739x include an SD input standard auto detect feature that can be enabled by setting Subaddress 0x87, Bit 5 to Bit 1.

When enabled, the ADV739x can automatically identify an NTSC or PAL B/D/G/H/I input stream. The ADV739x automatically updates the subcarrier frequency registers with the appropriate value for the identified standard. The ADV739x is also configured to correctly encode the identified standard.

The SD standard bits (Subaddress 0x80, Bits[1:0]) and the subcarrier frequency registers are not updated to reflect the identified standard. All registers retain their default or user-defined values.

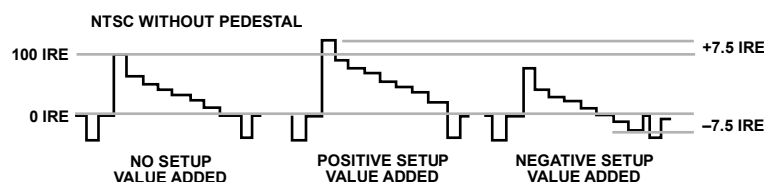

Figure 70. Examples of Brightness Control Values

DOUBLE BUFFERING

**Subaddress 0x33, Bit 7 for ED/HD,
Subaddress 0x88, Bit 2 for SD**

Double-buffered registers are updated once per field. Double buffering improves overall performance because modifications to register settings are not made during active video, but take effect prior to the start of the active video on the next field.

Using Subaddress 0x33, Bit 7, double buffering can be activated on the following ED/HD registers: ED/HD Gamma A and Gamma B curves, and ED/HD CGMS registers.

Using Subaddress 0x88, Bit 2, double buffering can be activated on the following SD registers: SD Gamma A and Gamma B curves, SD Y scale, SD Cr scale, SD Cb scale, SD brightness, SD closed captioning, and SD Macrovision Bits[5:0] (Subaddress 0xE0, Bits[5:0]).

PROGRAMMABLE DAC GAIN CONTROL

Subaddress 0x0B

It is possible to adjust the DAC output signal gain up or down from its absolute level. This is illustrated in Figure 71.

DAC 1 to DAC 3 are controlled by Register 0x0B.

CASE A

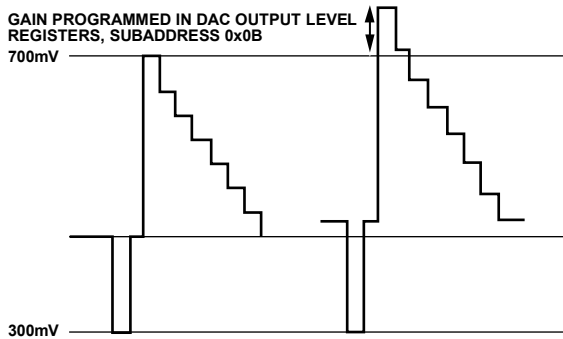

CASE B

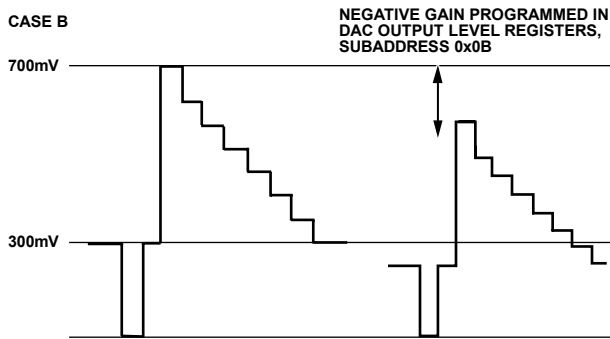

Figure 71. Programmable DAC Gain—Positive and Negative Gain

In Case A of Figure 71, the video output signal is gained. The absolute level of the sync tip and blanking level both increase with respect to the reference video output signal. The overall gain of the signal is increased from the reference signal.

In Case B of Figure 71, the video output signal is reduced. The absolute level of the sync tip and blanking level both decrease with respect to the reference video output signal. The overall gain of the signal is reduced from the reference signal.

The range of this feature is specified for ±7.5% of the nominal output from the DACs. For example, if the output current of the DAC is 4.33 mA, the DAC gain control feature can change this output current from 4.008 mA (−7.5%) to 4.658 mA (+7.5%).

The reset value of the control registers is 0x00, that is, nominal DAC current is output. Table 45 is an example of how the output current of the DACs varies for a nominal 4.33 mA output current.

Table 45. DAC Gain Control

Subaddress 0x0B	DAC Current (mA)	% Gain	Note
0100 0000 (0x40)	4.658	7.5000%	
0011 1111 (0x3F)	4.653	7.3820%	
0011 1110 (0x3E)	4.648	7.3640%	
...	
...	
0000 0010 (0x02)	4.43	0.0360%	
0000 0001 (0x01)	4.38	0.0180%	
0000 0000 (0x00)	4.33	0.0000%	Reset value, nominal
1111 1111 (0xFF)	4.25	−0.0180%	
1111 1110 (0xFE)	4.23	−0.0360%	
...	
...	
1100 0010 (0xC2)	4.018	−7.3640%	
1100 0001 (0xC1)	4.013	−7.3820%	
1100 0000 (0xC0)	4.008	−7.5000%	

GAMMA CORRECTION

**Subaddress 0x44 to Subaddress 0x57 for ED/HD,
Subaddress 0xA6 to Subaddress 0xB9 for SD**

Generally, gamma correction is applied to compensate for the nonlinear relationship between signal input and output brightness level (as perceived on a CRT). It can also be applied wherever nonlinear processing is used.

Gamma correction uses the function

$$Signal_{OUT} = (Signal_{IN})^\gamma$$

where γ = gamma correction factor.

Gamma correction is available for SD and ED/HD video. For both variations, there are 20, 8-bit registers. They are used to program Gamma Correction Curve A and Curve B.

ED/HD gamma correction is enabled using Subaddress 0x35, Bit 5. ED/HD Gamma Correction Curve A is programmed at Subaddress 0x44 to Subaddress 0x4D, and ED/HD Gamma Correction Curve B is programmed at Subaddress 0x4E to Subaddress 0x57.

ADV7390/ADV7391/ADV7392/ADV7393

SD gamma correction is enabled using Subaddress 0x88, Bit 6. SD Gamma Correction Curve A is programmed at Subaddress 0xA6 to Subaddress 0xAF, and SD Gamma Correction Curve B is programmed at Subaddress 0xB0 to Subaddress 0xB9.

Gamma correction is performed on the luma data only. The user can choose one of two correction curves, Curve A or Curve B. Only one of these curves can be used at a time. For ED/HD gamma correction, curve selection is controlled using Subaddress 0x35, Bit 4. For SD gamma correction, curve selection is controlled using Subaddress 0x88, Bit 7.

The shape of the gamma correction curve is controlled by defining the curve response at 10 different locations along the curve. By altering the response at these locations, the shape of the gamma correction curve can be modified. Between these points, linear interpolation is used to generate intermediate values. Considering the curve to have a total length of 256 points, the 10 programmable locations are at points 24, 32, 48, 64, 80, 96, 128, 160, 192, and 224. Locations 0, 16, 240, and 255 are fixed and cannot be changed.

From curve locations 16 to 240, the values at the programmable locations and, therefore, the response of the gamma correction curve, should be calculated to produce the following result:

$$X_{DESIRED} = (X_{INPUT})^\gamma$$

where:

$X_{DESIRED}$ = desired gamma corrected output

X_{INPUT} = linear input signal

γ = gamma correction factor

To program the gamma correction registers, calculate the 10 programmable curve values using the following formula:

$$\gamma_n = \left(\left(\frac{n-16}{240-16} \right)^\gamma \times (240-16) \right) + 16$$

where:

γ_n = value to be written into the gamma correction register for point n on the gamma correction curve

n = 24, 32, 48, 64, 80, 96, 128, 160, 192, or 224

γ = gamma correction factor

For example, setting $\gamma = 0.5$ for all programmable curve data points results in the following γ_n values:

$$\gamma_{24} = [(8/224)^{0.5} \times 224] + 16 = 58$$

$$\gamma_{32} = [(16/224)^{0.5} \times 224] + 16 = 76$$

$$\gamma_{48} = [(32/224)^{0.5} \times 224] + 16 = 101$$

$$\gamma_{64} = [(48/224)^{0.5} \times 224] + 16 = 120$$

$$\gamma_{80} = [(64/224)^{0.5} \times 224] + 16 = 136$$

$$\gamma_{96} = [(80/224)^{0.5} \times 224] + 16 = 150$$

$$\gamma_{128} = [(112/224)^{0.5} \times 224] + 16 = 174$$

$$\gamma_{160} = [(144/224)^{0.5} \times 224] + 16 = 195$$

$$\gamma_{192} = [(176/224)^{0.5} \times 224] + 16 = 214$$

$$\gamma_{224} = [(208/224)^{0.5} \times 224] + 16 = 232$$

where the sum of each equation is rounded to the nearest integer.

The gamma curves in Figure 72 and Figure 73 are examples only; any user-defined curve in the range from 16 to 240 is acceptable.

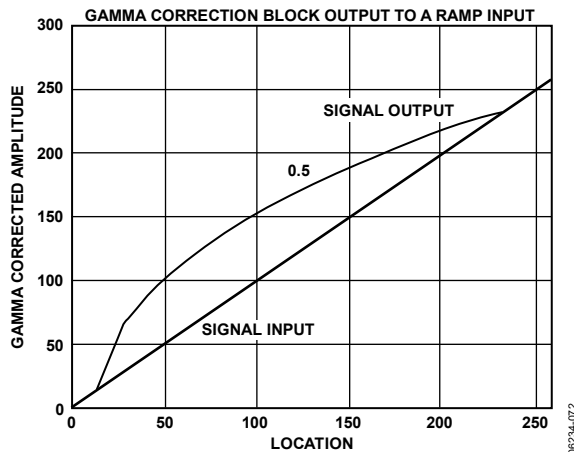

Figure 72. Signal Input (Ramp) and Signal Output for Gamma 0.5

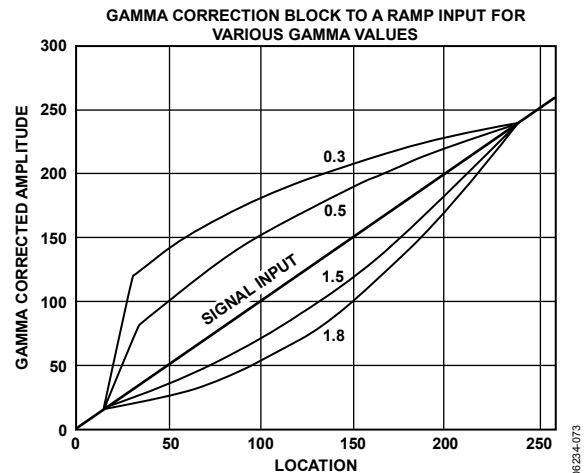

Figure 73. Signal Input (Ramp) and Selectable Output Curves

ED/HD SHARPNESS FILTER AND ADAPTIVE FILTER CONTROLS

Subaddress 0x40, Subaddress 0x58 to Subaddress 0x5D

There are three filter modes available on the ADV739x: sharpness filter mode and two adaptive filter modes.

ED/HD Sharpness Filter Mode

To enhance or attenuate the Y signal in the frequency ranges shown in Figure 74, the ED/HD sharpness filter must be enabled (Subaddress 0x31, Bit 7 = 1) and the ED/HD adaptive filter must be disabled (Subaddress 0x35, Bit 7 = 0).

To select one of the 256 individual responses, the corresponding gain values, ranging from -8 to +7 for each filter, must be programmed into the ED/HD sharpness filter gain register at Subaddress 0x40.

ED/HD Adaptive Filter Mode

In ED/HD adaptive filter mode, the following registers are used:

- ED/HD Adaptive Filter Threshold A
- ED/HD Adaptive Filter Threshold B
- ED/HD Adaptive Filter Threshold C
- ED/HD Adaptive Filter Gain 1
- ED/HD Adaptive Filter Gain 2
- ED/HD Adaptive Filter Gain 3
- ED/HD sharpness filter gain register

To activate the adaptive filter control, the ED/HD sharpness filter and the ED/HD adaptive filter must be enabled (Subaddress 0x31, Bit 7 = 1, and Subaddress 0x35, Bit 7 = 1, respectively).

The derivative of the incoming signal is compared to the three programmable threshold values: ED/HD Adaptive Filter Threshold A, Threshold B, and Threshold C (Subaddress 0x5B, Subaddress 0x5C, and Subaddress 0x5D). The recommended threshold range is 16 to 235, although any value in the range of 0 to 255 can be used.

The edges can then be attenuated with the settings in the ED/HD Adaptive Filter Gain 1, Gain 2, and Gain 3 registers (Subaddress 0x58, Subaddress 0x59 and Subaddress 0x5A), and the ED/HD sharpness filter gain register (Subaddress 0x40).

There are two adaptive filter modes available. The mode is selected using the ED/HD adaptive filter mode control (Subaddress 0x35, Bit 6):

- Mode A is used when the ED/HD adaptive filter mode control is set to 0. In this case, Filter B (LPF) is used in the adaptive filter block. In addition, only the programmed values for Gain B in the ED/HD sharpness filter gain register and ED/HD Adaptive Filter Gain 1, Gain 2, and Gain 3 registers are applied when needed. The Gain A values are fixed and cannot be changed.
- Mode B is used when ED/HD adaptive filter mode control is set to 1. In this mode, a cascade of Filter A and Filter B is used. Both settings for Gain A and Gain B in the ED/HD sharpness filter gain register and ED/HD Adaptive Filter Gain 1, Gain 2, and Gain 3 registers become active when needed.

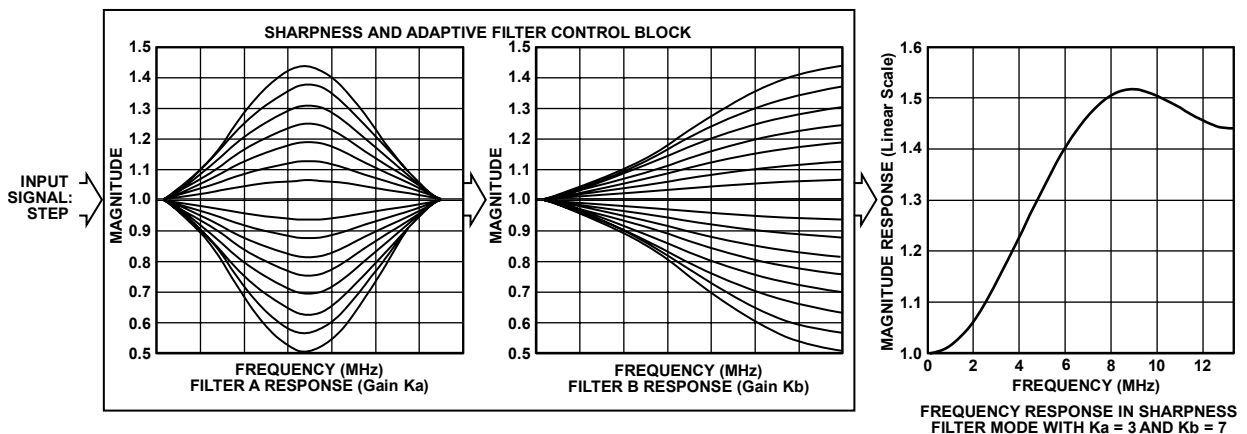

Figure 74. ED/HD Sharpness and Adaptive Filter Control Block

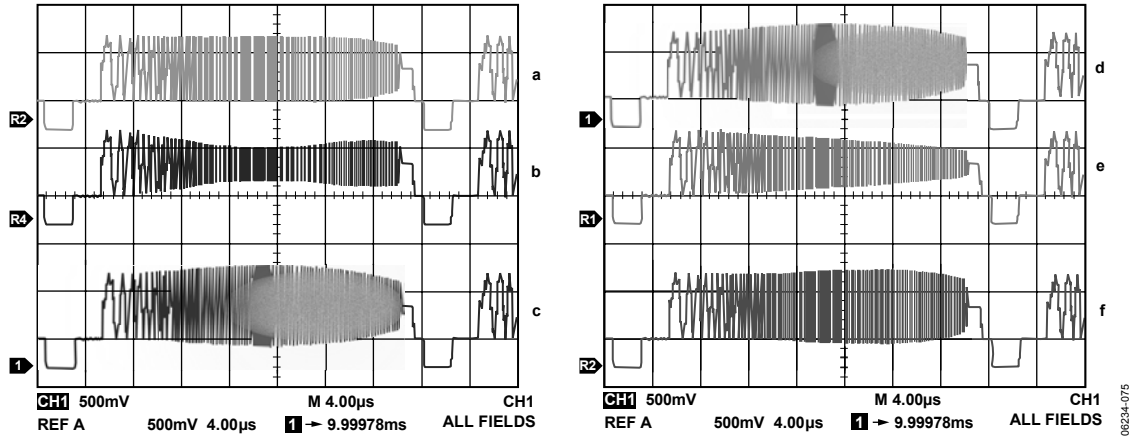

Figure 75. ED/HD Sharpness Filter Control with Different Gain Settings for ED/HD Sharpness Filter Gain Values

ED/HD SHARPNESS FILTER AND ADAPTIVE FILTER APPLICATION EXAMPLES

Sharpness Filter Application

The ED/HD sharpness filter can be used to enhance or attenuate the Y video output signal. The register settings in Table 46 were used to achieve the results shown in Figure 75. Input data was generated by an external signal source.

Table 46. ED/HD Sharpness Control

Subaddress	Register Setting	Reference ¹
0x00	0xFC	
0x01	0x10	
0x02	0x20	
0x30	0x00	
0x31	0x81	
0x40	0x00	a
0x40	0x08	b
0x40	0x04	c
0x40	0x40	d
0x40	0x80	e
0x40	0x22	f

¹ See Figure 75.

Adaptive Filter Control Application

The register settings in Table 47 are used to obtain the results shown in Figure 77, that is, to remove the ringing on the input Y signal, as shown in Figure 76. Input data is generated by an external signal source.

Table 47. Register Settings for Figure 77

Subaddress	Register Setting
0x00	0xFC
0x01	0x38
0x02	0x20
0x30	0x00
0x31	0x81
0x35	0x80
0x40	0x00
0x58	0xAC
0x59	0x9A
0x5A	0x88
0x5B	0x28
0x5C	0x3F
0x5D	0x64

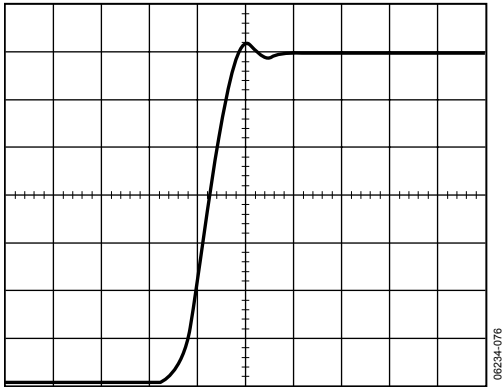

Figure 76. Input Signal to ED/HD Adaptive Filter

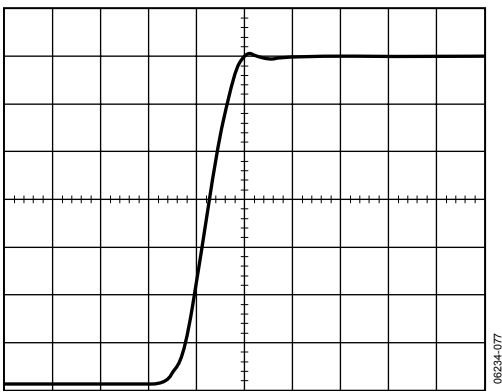

Figure 77. Output Signal from ED/HD Adaptive Filter (Mode A)

When changing the adaptive filter mode to Mode B (Subaddress 0x35, Bit 6), the output shown in Figure 78 can be obtained.

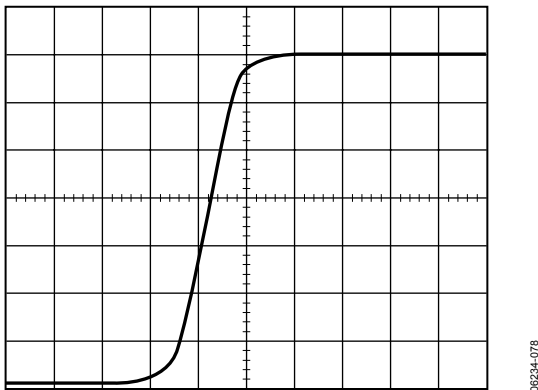

Figure 78. Output Signal from ED/HD Adaptive Filter (Mode B)

SD DIGITAL NOISE REDUCTION

Subaddress 0xA3 to Subaddress 0xA5

Digital noise reduction (DNR) is applied to the Y data only. A filter block selects the high frequency, low amplitude components of the incoming signal (DNR input select). The absolute value of the filter output is compared to a programmable threshold value (DNR threshold control). There are two DNR modes available: DNR mode and DNR sharpness mode.

In DNR mode, if the absolute value of the filter output is smaller than the threshold, it is assumed to be noise. A programmable amount (coring gain border, coring gain data) of this noise signal is subtracted from the original signal. In DNR sharpness mode, if the absolute value of the filter output is less than the programmed threshold, it is assumed to be noise as before. However, if the level exceeds the threshold, now being identified as a valid signal, a fraction of the signal (coring gain border, coring gain data) is added to the original signal to boost high frequency components and sharpen the video image.

In MPEG systems, it is common to process the video information in blocks of 8 pixels × 8 pixels for MPEG2 systems, or 16 pixels × 16 pixels for MPEG1 systems (block size control). DNR can be applied to the resulting block transition areas known to contain noise. Generally, the block transition area contains two pixels. It is possible to define this area to contain four pixels (border area).

It is also possible to compensate for variable block positioning or differences in YCrCb pixel timing with the use of the DNR block offset.

The digital noise reduction registers are three 8-bit registers. They are used to control the DNR processing.

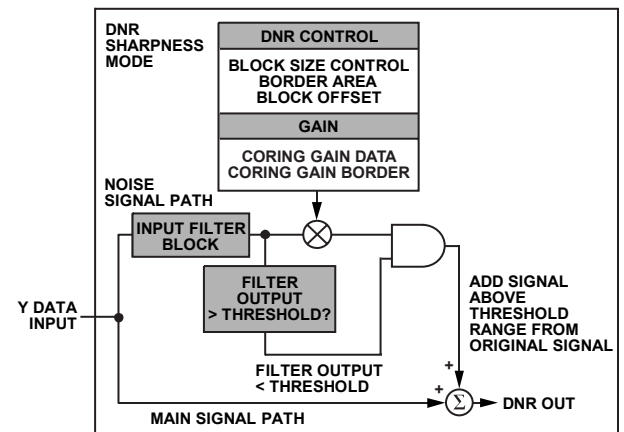
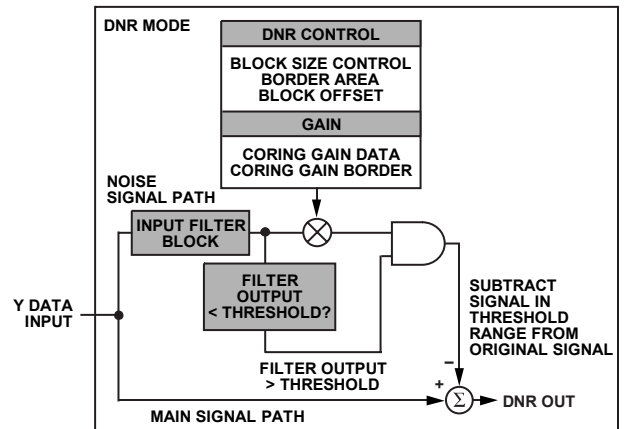

Figure 79. SD DNR Block Diagram

Coring Gain Border—Subaddress 0xA3, Bits[3:0]

These four bits are assigned to the gain factor applied to border areas. In DNR mode, the range of gain values is 0 to 1 in increments of 1/8. This factor is applied to the DNR filter output that lies below the set threshold range. The result is then subtracted from the original signal.

In DNR sharpness mode, the range of gain values is 0 to 0.5 in increments of 1/16. This factor is applied to the DNR filter output that lies above the threshold range. The result is added to the original signal.

Coring Gain Data—Subaddress 0xA3, Bits[7:4]

These four bits are assigned to the gain factor applied to the luma data inside the MPEG pixel block. In DNR mode, the range of gain values is 0 to 1 in increments of 1/8. This factor is applied to the DNR filter output that lies below the set threshold range. The result is then subtracted from the original signal.

In DNR sharpness mode, the range of gain values is 0 to 0.5 in increments of 1/16. This factor is applied to the DNR filter output that lies above the threshold range. The result is added to the original signal.

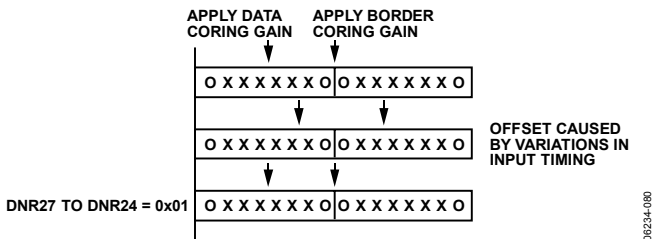

Figure 80. SD DNR Offset Control

DNR Threshold—Subaddress 0xA4, Bits[5:0]

These six bits are used to define the threshold value in the range of 0 to 63. The range is an absolute value.

Border Area—Subaddress 0xA4, Bit 6

When this bit is set to Logic 1, the block transition area can be defined to consist of four pixels. If this bit is set to Logic 0, the border transition area consists of two pixels, where one pixel refers to two clock cycles at 27 MHz.

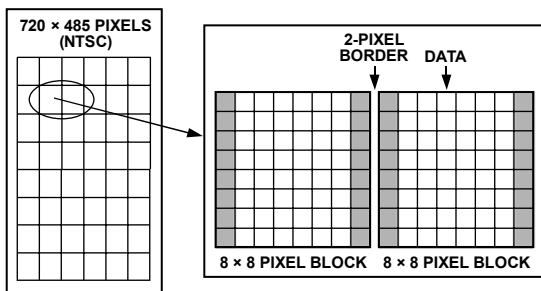

Figure 81. SD DNR Border Area

Block Size—Subaddress 0xA4, Bit 7

This bit is used to select the size of the data blocks to be processed. Setting the block size control function to Logic 1 defines a 16 pixel × 16 pixel data block, and Logic 0 defines an 8 pixel × 8 pixel data block, where one pixel refers to two clock cycles at 27 MHz.

DNR Input Select—Subaddress 0xA5, Bits[2:0]

These three bits are assigned to select the filter that is applied to the incoming Y data. The signal that lies in the pass band of the selected filter is the signal processed by DNR. Figure 82 shows the filter responses selectable with this control.

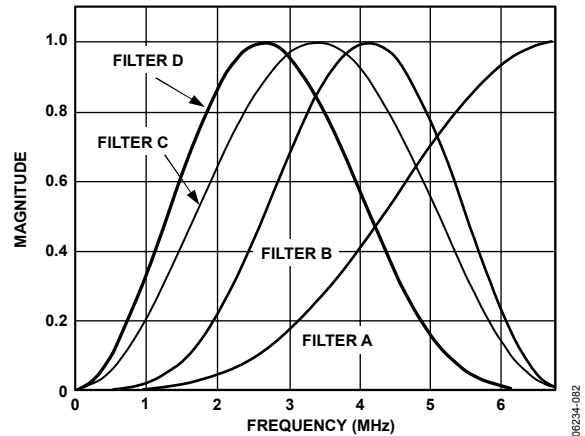

Figure 82. SD DNR Input Select

DNR Mode—Subaddress 0xA5, Bit 4

This bit controls the DNR mode selected. Logic 0 selects DNR mode; Logic 1 selects DNR sharpness mode.

DNR works on the principle of defining low amplitude, high frequency signals as probable noise and subtracting this noise from the original signal.

In DNR mode, it is possible to subtract a fraction of the signal that lies below the set threshold, assumed to be noise, from the original signal. The threshold is set in DNR Register 1.

When DNR sharpness mode is enabled, it is possible to add a fraction of the signal that lies above the set threshold to the original signal because this data is assumed to be valid data and not noise. The overall effect is that the signal is boosted (similar to using the extended SSAF filter).

Block Offset Control—Subaddress 0xA5, Bits[7:4]

Four bits are assigned to this control that allows a shift in the data block of 15 pixels maximum. The coring gain positions are fixed. The block offset shifts the data in steps of one pixel such that the border coring gain factors can be applied at the same position regardless of variations in input timing of the data.

SD ACTIVE VIDEO EDGE CONTROL

Subaddress 0x82, Bit 7

The ADV739x is able to control fast rising and falling signals at the start and end of active video to minimize ringing.

When the active video edge control feature is enabled (Subaddress 0x82, Bit 7 = 1), the first three pixels and the last three pixels of the active video on the luma channel are scaled so that maximum transitions on these pixels are not possible.

At the start of active video, the first three pixels are multiplied by $\frac{1}{8}$, $\frac{1}{2}$, and $\frac{7}{8}$, respectively. Approaching the end of active video, the last three pixels are multiplied by $\frac{7}{8}$, $\frac{1}{2}$, and $\frac{1}{8}$, respectively. All other active video pixels pass through unprocessed.

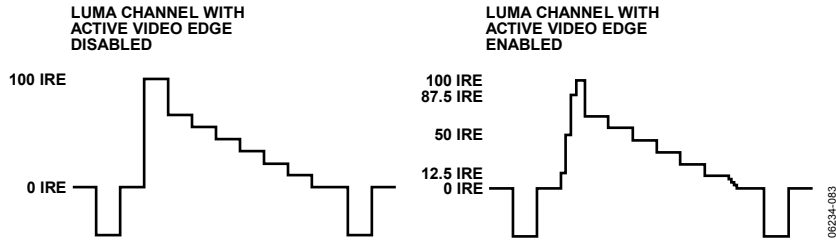

Figure 83. Example of Active Video Edge Functionality

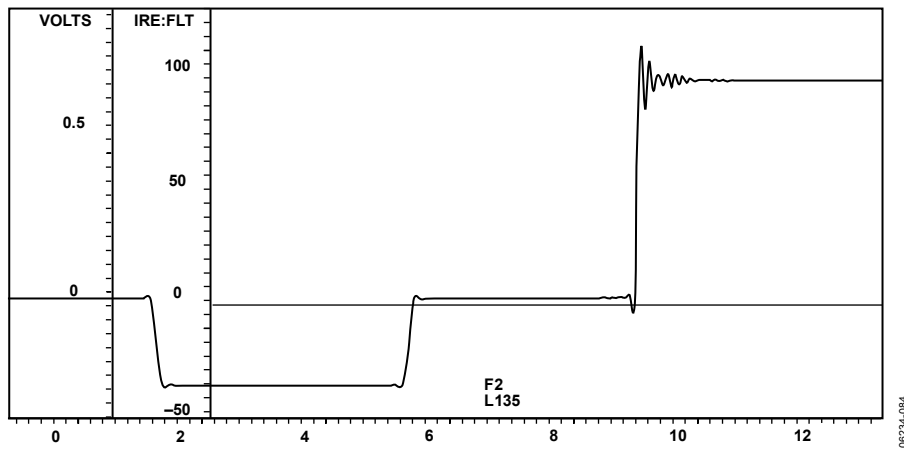

Figure 84. Example of Video Output with Subaddress 0x82, Bit 7 = 0

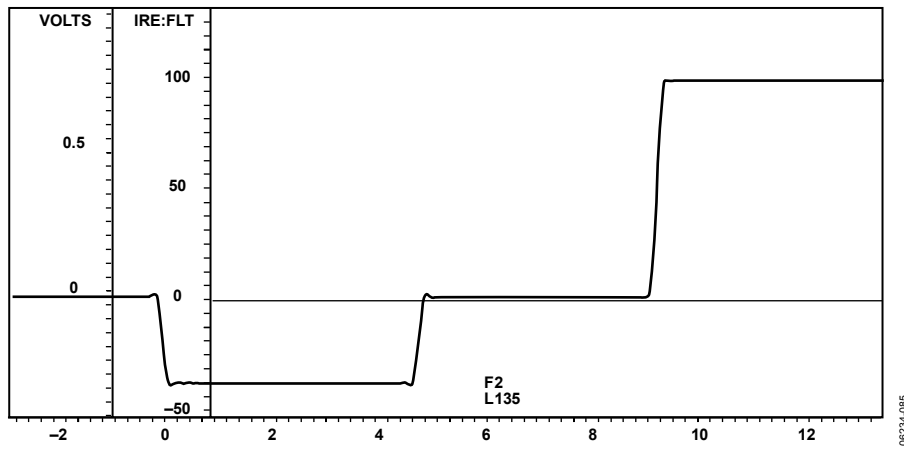

Figure 85. Example of Video Output with Subaddress 0x82, Bit 7 = 1

ADV7390/ADV7391/ADV7392/ADV7393

EXTERNAL HORIZONTAL AND VERTICAL SYNCHRONIZATION CONTROL

For timing synchronization purposes, the ADV739x is able to accept either EAV/SAV time codes embedded in the input pixel data or external synchronization signals provided on the $\overline{\text{HSYNC}}$ and $\overline{\text{VSYNC}}$ pins (see Table 48). It is also possible to output synchronization signals on the $\overline{\text{HSYNC}}$ and $\overline{\text{VSYNC}}$ pins (see Table 49 to Table 51).

Table 48. Timing Synchronization Signal Input Options

Signal	Pin	Condition
SD $\overline{\text{HSYNC}}$ In	$\overline{\text{HSYNC}}$	SD Slave Timing Mode 1, Mode 2, or Mode 3 Selected (Subaddress 0x8A[2:0]). ¹
SD $\overline{\text{VSYNC}}$ /FIELD In	$\overline{\text{VSYNC}}$	SD Slave Timing Mode 1, Mode 2, or Mode 3 Selected (Subaddress 0x8A[2:0]). ¹
ED/HD $\overline{\text{HSYNC}}$ In	$\overline{\text{HSYNC}}$	ED/HD Timing Synchronization Inputs Enabled (Subaddress 0x30, Bit 2 = 0).
ED/HD $\overline{\text{VSYNC}}$ /FIELD In	$\overline{\text{VSYNC}}$	ED/HD Timing Synchronization Inputs Enabled (Subaddress 0x30, Bit 2 = 0).

¹ SD and ED/HD timing synchronization outputs must also be disabled (Subaddress 0x02[7:6] = 00).

Table 49. Timing Synchronization Signal Output Options

Signal	Pin	Condition
SD $\overline{\text{HSYNC}}$ Out	$\overline{\text{HSYNC}}$	SD Timing Synchronization Outputs enabled (Subaddress 0x02, Bit 6 = 1). ¹
SD $\overline{\text{VSYNC}}$ /FIELD Out	$\overline{\text{VSYNC}}$	SD Timing Synchronization Outputs enabled (Subaddress 0x02, Bit 6 = 1). ¹
ED/HD $\overline{\text{HSYNC}}$ Out	$\overline{\text{HSYNC}}$	ED/HD Timing Synchronization Outputs enabled (Subaddress 0x02, Bit 7 = 1). ²
ED/HD $\overline{\text{VSYNC}}$ /FIELD Out	$\overline{\text{VSYNC}}$	ED/HD Timing Synchronization Outputs enabled (Subaddress 0x02, Bit 7 = 1). ²

¹ ED/HD timing synchronization outputs must also be disabled (Subaddress 0x02, Bit 7 = 0).

² ED/HD timing synchronization inputs must also be disabled, that is, embedded EAV/SAV timing codes must be enabled (Subaddress 0x30, Bit 2 = 1).

Table 50. $\overline{\text{HSYNC}}$ Output Control¹

ED/HD Input Sync Format (0x30, Bit 2)	ED/HD $\overline{\text{HSYNC}}$ Control (0x34, Bit 1)	ED/HD Sync Output Enable (0x02, Bit 7)	SD Sync Output Enable (0x02, Bit 6)	Signal on $\overline{\text{HSYNC}}$ Pin	Duration
x	x	0	0	Tristate.	–
x	x	0	1	Pipelined SD $\overline{\text{HSYNC}}$.	See Error! Reference source not found..
0	0	1	x	Pipelined ED/HD $\overline{\text{HSYNC}}$.	As per $\overline{\text{HSYNC}}$ timing.
1	0	1	x	Pipelined ED/HD $\overline{\text{HSYNC}}$ based on AV Code H bit.	Same as line blanking interval.
x	1	1	x	Pipelined ED/HD $\overline{\text{HSYNC}}$ based on horizontal counter.	Same as embedded $\overline{\text{HSYNC}}$.

¹ In all ED/HD standards where there is a $\overline{\text{HSYNC}}$ output, the start of the $\overline{\text{HSYNC}}$ pulse is aligned with the falling edge of the embedded $\overline{\text{HSYNC}}$ in the output video.

Table 51. $\overline{\text{VSYNC}}$ Output Control¹

ED/HD Input Sync Format (0x30, Bit 2)	ED/HD $\overline{\text{VSYNC}}$ Control (0x34, Bit 2)	ED/HD Sync Output Enable (0x02, Bit 7)	SD Sync Output Enable (0x02, Bit 6)	Video Standard	Signal on $\overline{\text{VSYNC}}$ Pin	Duration
x	x	0	0	x	Tristate.	–
x	x	0	1	Interlaced	Pipelined SD $\overline{\text{VSYNC}}$ /Field.	See Error! Reference source not found..
0	0	1	x	x	Pipelined ED/HD $\overline{\text{VSYNC}}$ or field signal.	As per $\overline{\text{VSYNC}}$ or Field signal timing.
1	0	1	x	All HD interlaced standards	Pipelined Field signal based on AV Code F bit.	Field.
1	0	1	x	All ED/HD progressive standards	Pipelined $\overline{\text{VSYNC}}$ based on AV Code V bit.	Vertical blanking interval.
x	1	1	x	All ED/HD standards except 525p	Pipelined ED/HD $\overline{\text{VSYNC}}$ based on vertical counter.	Aligned with serration lines.
x	1	1	x	525p	Pipelined ED/HD $\overline{\text{VSYNC}}$ based on vertical counter.	Vertical blanking interval.

¹ In all ED/HD standards where there is a $\overline{\text{VSYNC}}$ output, the start of the $\overline{\text{VSYNC}}$ pulse is aligned with the falling edge of the embedded $\overline{\text{VSYNC}}$ in the output video.

LOW POWER MODE

Subaddress 0x0D, Bits[2:0]

For power sensitive applications, the ADV739x supports an Analog Devices, Inc. proprietary low power mode of operation. To utilize this low power mode, the DACs must be operating in full-drive mode ($R_{SET} = 510 \Omega$, $R_L = 37.5 \Omega$). Low power mode is not available in low drive mode ($R_{SET} = 4.12 \text{ k}\Omega$, $R_L = 300 \Omega$). Low power mode can be independently enabled or disabled on each DAC using Subaddress 0x0D, Bits[2:0]. Low power mode is disabled by default on all DACs.

In low power mode, DAC current consumption is content dependent, and on a typical video stream, it can be reduced by as much as 40%. For applications requiring the highest possible video performance, low power mode should be disabled.

CABLE DETECTION

Subaddress 0x10, Bits[1:0]

The ADV739x includes an Analog Devices, Inc. proprietary cable detection feature.

The cable detection feature is available on DAC 1 and DAC 2 when operating in full-drive mode ($R_{SET} = 510 \Omega$, $R_L = 37.5 \Omega$, assuming a connected cable). The feature is not available in low-drive mode ($R_{SET} = 4.12 \text{ k}\Omega$, $R_L = 300 \Omega$). For a DAC to be monitored, the DAC must be powered up in Subaddress 0x00.

The cable detection feature can be used with all SD, ED, and HD video standards. It is available for all output configurations, that is, CVBS, YC, YPrPb, and RGB output configurations.

For CVBS/YC output configurations, both DAC 1 and DAC 2 are monitored, that is, the CVBS and YC luma outputs are monitored. For YPrPb and RGB output configurations, only DAC 1 is monitored, that is, the luma or green output is monitored.

Once per frame, the ADV739x monitors DAC 1 and/or DAC 2, updating Subaddress 0x10, Bit 0 and/or Bit 1, respectively. If a cable is detected on one of the DACs, the relevant bit is set to 0. If not, the bit is set to 1.

DAC AUTO POWER-DOWN

Subaddress 0x10, Bit 4

For power sensitive applications, a DAC auto power-down feature can be enabled using Subaddress 0x10, Bit 4. This feature is only available when the cable detection feature is enabled.

With this feature enabled, the cable detection circuitry monitors DAC 1 and/or DAC 2 once per frame, and if they are unconnected, automatically powers down some or all of the DACs. Which DAC or DACs are powered down depends on the selected output configuration.

For CVBS/YC output configurations, if DAC 1 is unconnected, only DAC 1 powers down. If DAC 2 is unconnected, DAC 2 and DAC 3 power down.

For YPrPb and RGB output configurations, if DAC 1 is unconnected, all three DACs are powered down. DAC 2 is not monitored for YPrPb and RGB output configurations.

Once per frame, DAC 1 and/or DAC 2 are monitored. If a cable is detected, the appropriate DAC or DACs remain powered up for the duration of the frame. If no cable is detected, the appropriate DAC or DACs power down until the next frame, when the process is repeated.

PIXEL AND CONTROL PORT READBACK

Subaddress 0x13, Subaddress 0x14, Subaddress 0x16

The ADV739x supports the readback of most digital inputs via the I²C/SPI MPU port. This feature is useful for board-level connectivity testing with upstream devices.

The pixel port (P[15:0] or P[7:0]), $\overline{\text{HSYNC}}$, $\overline{\text{VSYNC}}$, and SFL/MISO are available for readback via the MPU port. The readback registers are located at Subaddress 0x13, Subaddress 0x14, and Subaddress 0x16.

When using this feature, a clock signal should be applied to the CLKIN pin to register the levels applied to the input pins.

The SD input mode (Subaddress 0x01, Bits[6:4] = 000) must be selected when using this feature.

RESET MECHANISMS

Subaddress 0x17, Bit 1

A hardware reset is activated with a high-to-low transition on the RESET pin in accordance with the timing specifications. This resets all registers to their default values. After a hardware reset, the MPU port is configured for I²C operation. For correct device operation, a hardware reset is necessary after power-up.

The ADV739x also has a software reset accessible via the I²C/SPI MPU port. A software reset is activated by writing a 1 to Subaddress 0x17, Bit 1. This resets all registers to their default values. This bit is self-clearing, that is, after a 1 has been written to the bit, the bit automatically returns to 0.

When operating in SPI mode, a software reset does not cause the device to revert to I²C mode. For this to occur, a hardware reset via the $\overline{\text{RESET}}$ pin or a power-down needs to occur.

A hardware reset is necessary after power-up for correct device operation. If no hardware reset functionality is required by the application, the $\overline{\text{RESET}}$ pin can be connected to a RC network to provide the hardware reset necessary after power-up. After power-up, the time constant of the RC network holds the RESET pin low for long enough to cause a reset to take place. All subsequent resets can be done via software.

PRINTED CIRCUIT BOARD LAYOUT AND DESIGN

DAC CONFIGURATIONS

The ADV739x contains three DACs. All three DACs can be configured to operate in full-drive mode. Full-drive mode is defined as 34.7 mA full-scale current into a 37.5 Ω load, R_L . Full-drive is the recommended mode of operation for the DACs.

Alternatively, all three DACs can be configured to operate in low drive mode. Low drive mode is defined as 4.33 mA full-scale current into a 300 Ω load, R_L .

The ADV739x contains a R_{SET} pin. A resistor connected between the R_{SET} pin and AGND is used to control the full-scale output current and, therefore, the output voltage levels of DAC 1, DAC 2, and DAC 3. For full-drive operation, R_{SET} must have a value of 510 Ω and R_L must have a value of 37.5 Ω. For low drive operation, R_{SET} must have a value of 4.12 kΩ, and R_L must have a value of 300 Ω.

The resistor connected to the R_{SET} pin should have a 1% tolerance.

The ADV739x contains a compensation pin, COMP. A 2.2 nF compensation capacitor should be connected from the COMP pin to V_{AA} .

VIDEO OUTPUT BUFFER AND OPTIONAL OUTPUT FILTER

An output buffer is necessary on any DAC that operates in low drive mode ($R_{SET} = 4.12$ kΩ, $R_L = 300$ Ω). Analog Devices Inc. produces a range of op amps suitable for this application, for example, the [AD8061](#). For more information about line driver buffering circuits, see the relevant op amp data sheet.

An optional reconstruction (anti-imaging) low-pass filter (LPF) may be required on the ADV739x DAC outputs. The filter specifications vary with the application. The use of 16× (SD), 8× (ED), or 4× (HD) oversampling can remove the requirement for a reconstruction filter altogether.

For applications requiring an output buffer and reconstruction filter, the [ADA4430-1](#) and [ADA4411-3](#) integrated video filter buffers should be considered.

Table 52. ADV739x Output Rates

Input Mode (0x01, Bits[6:4])	Oversampling	Output Rate (MHz)
SD	Off	27 (2×)
	On	108 (8×)
	On	216 (16×)
ED	Off	27 (1×)
	On	108 (4×)
	On	216 (8×)
HD	Off	74.25 (1×)
	On	148.5 (2×)
	On	297 (4×)

Table 53. Output Filter Requirements

Application	Oversampling	Cutoff Frequency (MHz)	Attenuation -50 dB @ (MHz)
SD	2×	> 6.5	20.5
	8×	> 6.5	101.5
	16×	> 6.5	209.5
ED	1×	> 12.5	14.5
	4×	> 12.5	95.5
	8×	> 12.5	203.5
HD	1×	> 30	44.25
	2×	> 30	118.5
	4×	> 30	267

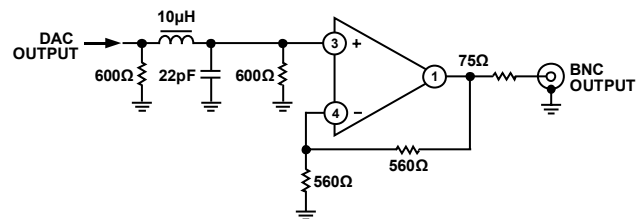

Figure 86. Example of Output Filter for SD, 16× Oversampling

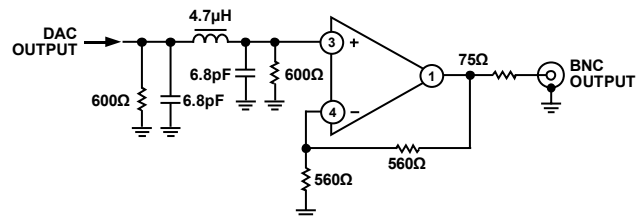

Figure 87. Example of Output Filter for ED, 8× Oversampling

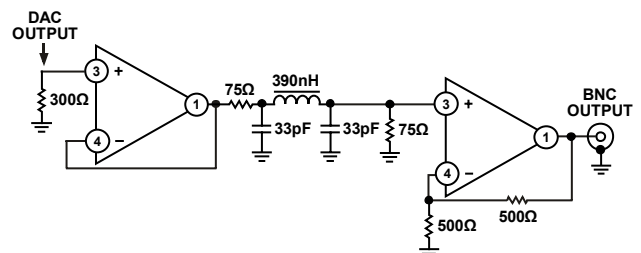

Figure 88. Example of Output Filter for HD, 4× Oversampling

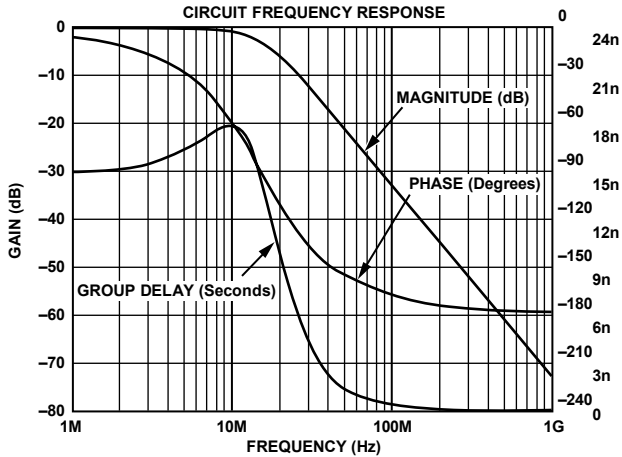

Figure 89. Output Filter Plot for SD, 16x Oversampling

06234-089

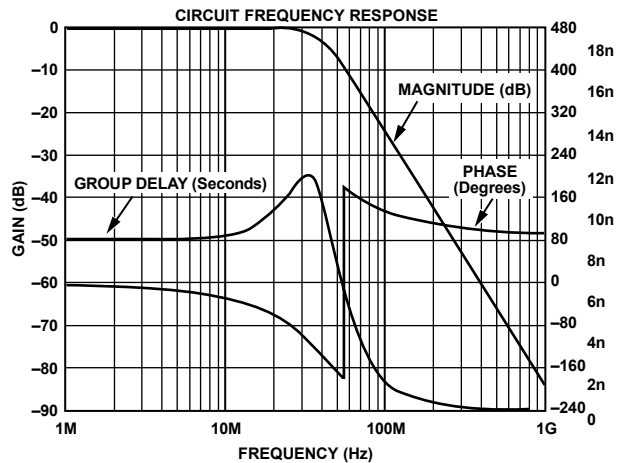

Figure 90. Output Filter Plot for ED, 8x Oversampling

06234-090

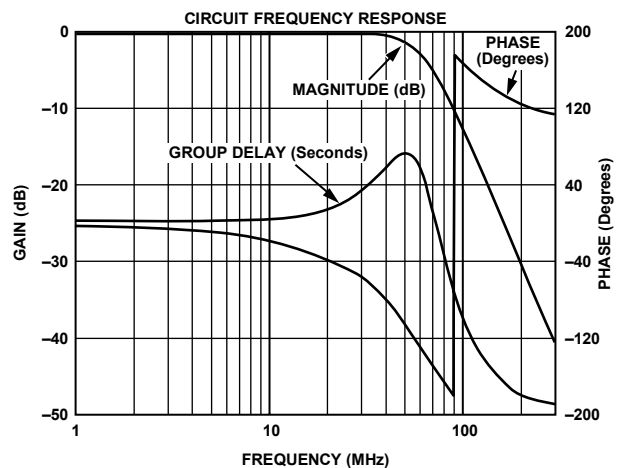

Figure 91. Output Filter Plot for HD, 4x Oversampling

06234-091

PRINTED CIRCUIT BOARD (PCB) LAYOUT

The ADV739x is a highly integrated circuit containing both precision analog and high speed digital circuitry. It has been designed to minimize interference effects on the integrity of the analog circuitry by the high speed digital circuitry. It is imperative that these same design and layout techniques be applied to the system-level design so that optimal performance is achieved.

The layout should be optimized for lowest noise on the ADV739x power and ground planes by shielding the digital inputs and providing good power supply decoupling.

It is recommended to use a 4-layer printed circuit board with ground and power planes separating the signal trace layer and the solder side layer.

Component Placement

Component placement should be carefully considered to separate noisy circuits, such as clock signals and high speed digital circuitry from analog circuitry.

The external loop filter components and components connected to the COMP and R_{SET} pins should be placed as close as possible to and on the same side of the PCB as the ADV739x. Adding vias to the PCB to get the components closer to the ADV739x is not recommended.

It is recommended that the ADV739x be placed as close as possible to the output connector, with the DAC output traces as short as possible.

The termination resistors on the DAC output traces should be placed as close as possible to and on the same side of the PCB as the ADV739x. The termination resistors should overlay the PCB ground plane.

External filter and buffer components connected to the DAC outputs should be placed as close as possible to the ADV739x to minimize the possibility of noise pickup from neighboring circuitry, and to minimize the effect of trace capacitance on output bandwidth. This is particularly important when operating in low drive mode (R_{SET} = 4.12 kΩ, R_L = 300 Ω).

Power Supplies

It is recommended that a separate regulated supply be provided for each power domain (V_{AA}, V_{DD}, V_{DD_IO}, and PV_{DD}). For optimal performance, linear regulators rather than switch mode regulators should be used. If switch mode regulators must be used, care must be taken with regard to the quality of the output voltage in terms of ripple and noise. This is particularly true for the V_{AA} and PV_{DD} power domains. Each power supply should be individually connected to the system power supply at a single point through a suitable filtering device, such as a ferrite bead.

ADV7390/ADV7391/ADV7392/ADV7393

Power Supply Decoupling

It is recommended that each power supply pin be decoupled with 10 nF and 0.1 μ F ceramic capacitors. The V_{AA} , PV_{DD} , $V_{DD_{IO}}$, and both V_{DD} pins should be individually decoupled to ground. The decoupling capacitors should be placed as close as possible to the ADV739x with the capacitor leads kept as short as possible to minimize lead inductance.

A 1 μ F tantalum capacitor is recommended across the V_{AA} supply in addition to the 10 nF and 0.1 μ F ceramic capacitors.

Power Supply Sequencing

The ADV739x is robust to all power supply sequencing combinations. Any particular sequence can be used.

Digital Signal Interconnect

The digital signal traces should be isolated as much as possible from the analog outputs and other analog circuitry. Digital signal traces should not overlay the V_{AA} or PV_{DD} power planes.

Due to the high clock rates used, avoid long clock traces to the ADV739x to minimize noise pickup.

Any pull-up termination resistors for the digital inputs should be connected to the V_{DD} power supply.

Any unused digital inputs should be tied to ground.

Analog Signal Interconnect

DAC output traces should be treated as transmission lines with appropriate measures taken to ensure optimal performance (for example, impedance matched traces). The DAC output traces should be kept as short as possible. The termination resistors on the DAC output traces should be placed as close as possible to and on the same side of the PCB as the ADV739x.

To avoid crosstalk between the DAC outputs, it is recommended that as much space as possible be left between the traces connected to the DAC output pins. Adding ground traces between the DAC output traces is also recommended.

TYPICAL APPLICATION CIRCUIT

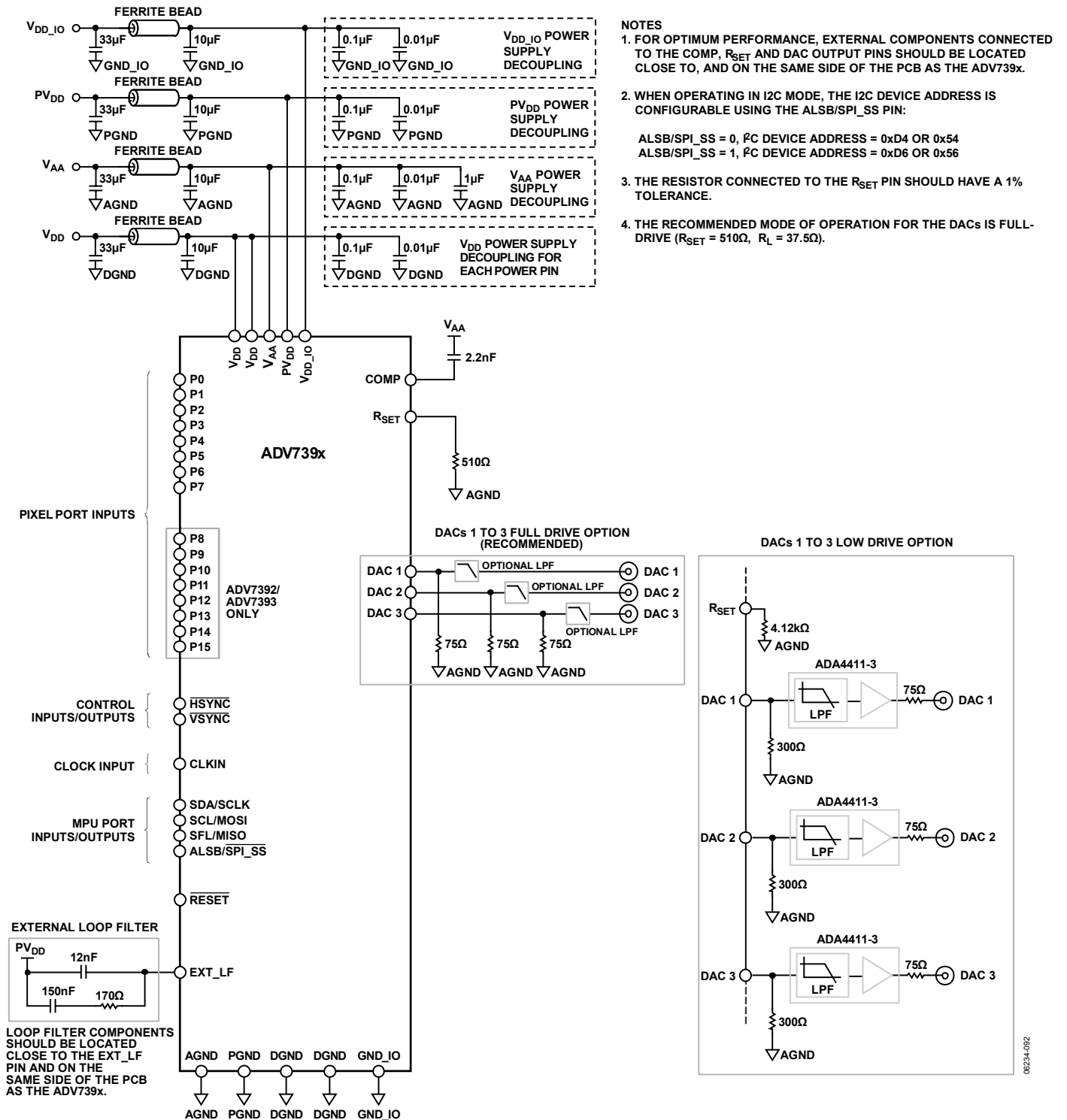

Figure 92. ADV739x Typical Application Circuit

APPENDIX 1—COPY GENERATION MANAGEMENT SYSTEM

SD CGMS

Subaddress 0x99 to Subaddress 0x9B

The ADV739x supports copy generation management system (CGMS) that conforms to the EIAJ CPR-1204 and ARIB TR-B15 standards. CGMS data is transmitted on Line 20 of the odd fields and Line 283 of even fields. Subaddress 0x99, Bits[6:5] control whether CGMS data is output on odd or even fields or both.

SD CGMS data can only be transmitted when the ADV739x is configured in NTSC mode. The CGMS data is 20 bits long. The CGMS data is preceded by a reference pulse of the same amplitude and duration as a CGMS bit (see Figure 93).

ED CGMS

Subaddress 0x41 to Subaddress 0x43

Subaddress 0x5E to Subaddress 0x6E

525p

The ADV739x supports copy generation management system (CGMS) in 525p mode in accordance with EIAJ CPR-1204-1.

When ED CGMS is enabled (Subaddress 0x32, Bit 6 = 1), 525p CGMS data is inserted on Line 41. The 525p CGMS data registers are at Subaddress 0x41, Subaddress 0x42, and Subaddress 0x43.

The ADV739x also supports CGMS Type B packets in 525p mode in accordance with CEA-805-A.

When ED CGMS Type B is enabled (Subaddress 0x5E, Bit 0 = 1), 525p CGMS Type B data is inserted on Line 40. The 525p CGMS Type B data registers are at Subaddress 0x5E to Subaddress 0x6E.

625p

The ADV739x supports copy generation management system (CGMS) in 625p mode in accordance with IEC 62375 (2004).

When ED CGMS is enabled (Subaddress 0x32, Bit 6 = 1), 625p CGMS data is inserted on Line 43. The 625p CGMS data registers are at Subaddress 0x42 and Subaddress 0x43.

HD CGMS

Subaddress 0x41 to Subaddress 0x43

Subaddress 0x5E to Subaddress 0x6E

The ADV739x supports copy generation management system (CGMS) in HD mode (720p and 1080i) in accordance with EIAJ CPR-1204-2.

When HD CGMS is enabled (Subaddress 0x32, Bit 6 = 1), 720p CGMS data is applied to Line 24 of the luminance vertical blanking interval.

When HD CGMS is enabled (Subaddress 0x32, Bit 6 = 1), 1080i CGMS data is applied to Line 19 and Line 582 of the luminance vertical blanking interval.

The HD CGMS data registers are at Subaddress 0x41, Subaddress 0x42, and Subaddress 0x43.

The ADV739x also supports CGMS Type B packets in HD mode (720p and 1080i) in accordance with CEA-805-A.

When HD CGMS Type B is enabled (Subaddress 0x5E, Bit 0 = 1), 720p CGMS data is applied to Line 23 of the luminance vertical blanking interval.

When HD CGMS Type B is enabled (Subaddress 0x5E, Bit 0 = 1), 1080i CGMS data is applied to Line 18 and Line 581 of the luminance vertical blanking interval.

The HD CGMS Type B data registers are at Subaddress 0x5E to Subaddress 0x6E.

CGMS CRC FUNCTIONALITY

If SD CGMS CRC (Subaddress 0x99, Bit 4) or ED/HD CGMS CRC (Subaddress 0x32, Bit 7) is enabled, the upper six CGMS data bits (C19 to C14) that comprise the 6-bit CRC check sequence are automatically calculated on the ADV739x. This calculation is based on the lower 14 bits (C13 to C0) of the data in the CGMS data registers, and the result is output with the remaining 14 bits to form the complete 20 bits of the CGMS data. The calculation of the CRC sequence is based on the polynomial $x^6 + x + 1$ with a preset value of 111111.

If SD CGMS CRC or ED/HD CGMS CRC is disabled, all 20 bits (C19 to C0) are output directly from the CGMS registers (CRC must be calculated by the user manually).

If ED/HD CGMS Type B CRC (Subaddress 0x5E, Bit 1) is enabled, the upper six CGMS Type B data bits (P122 to P127) that comprise the 6-bit CRC check sequence are automatically calculated on the ADV739x. This calculation is based on the lower 128 bits (H0 to H5 and P0 to P121) of the data in the CGMS Type B data registers. The result is output with the remaining 128 bits to form the complete 134 bits of the CGMS Type B data. The calculation of the CRC sequence is based on the polynomial $x^6 + x + 1$ with a preset value of 111111.

If ED/HD CGMS Type B CRC is disabled, all 134 bits (H0 to H5 and P0 to P127) are output directly from the CGMS Type B registers (CRC must be calculated by the user manually).

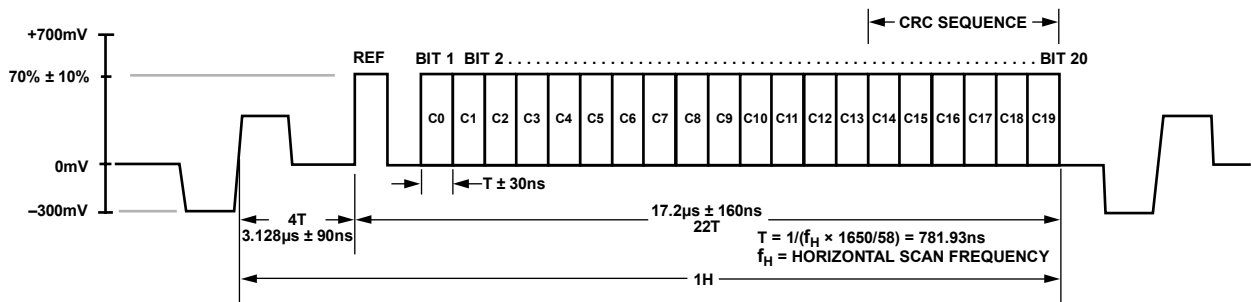
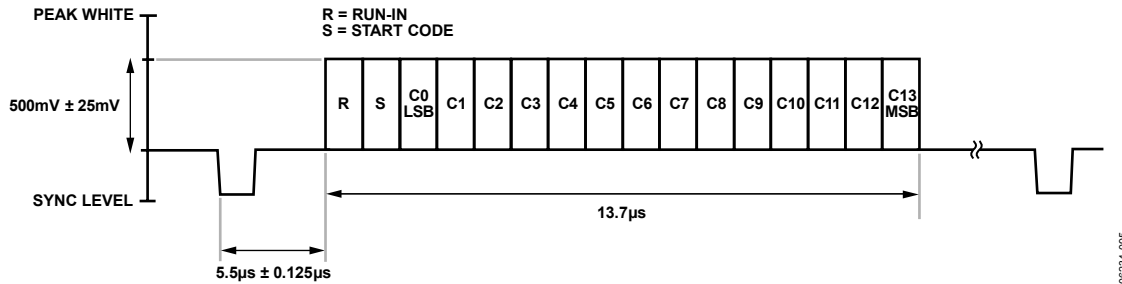
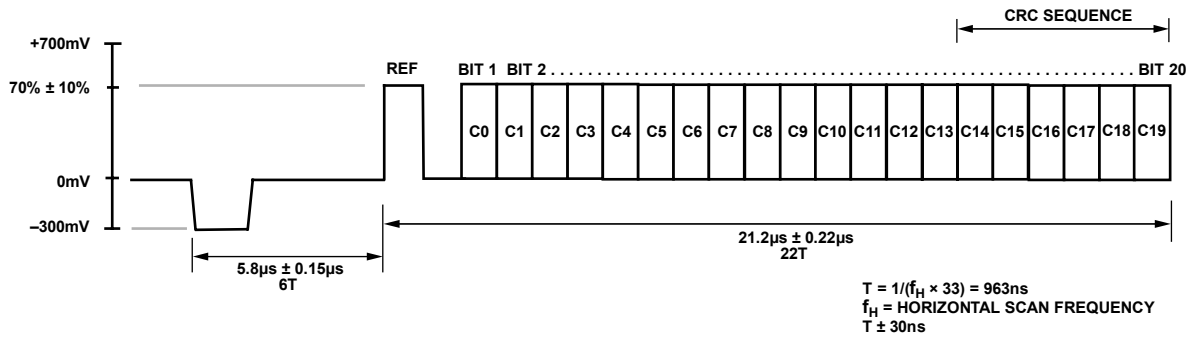
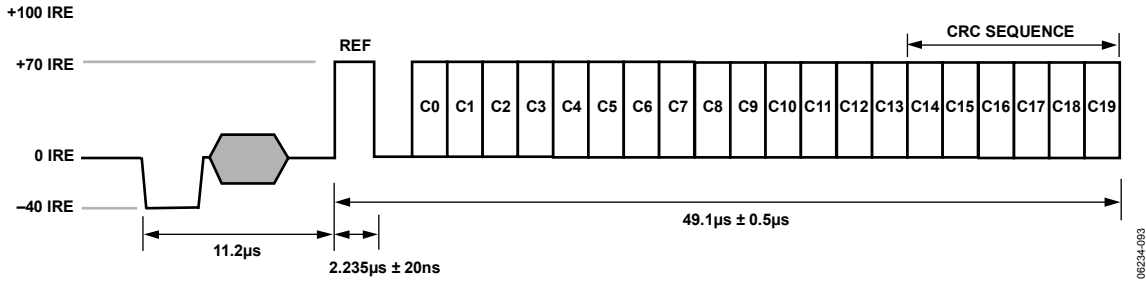

ADV7390/ADV7391/ADV7392/ADV7393

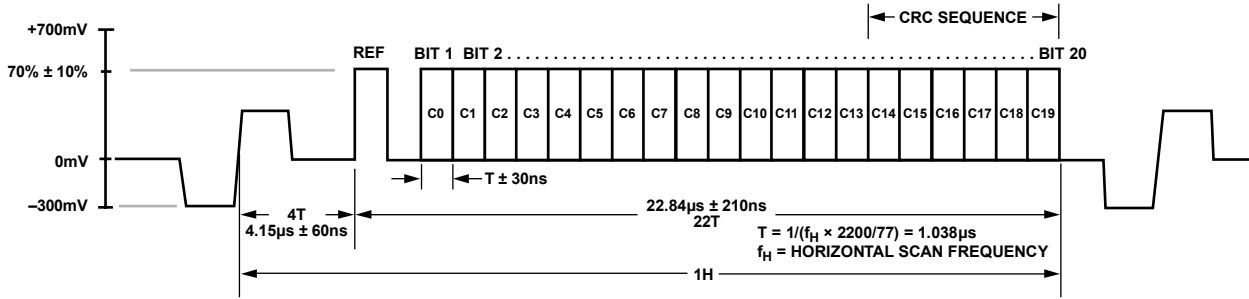
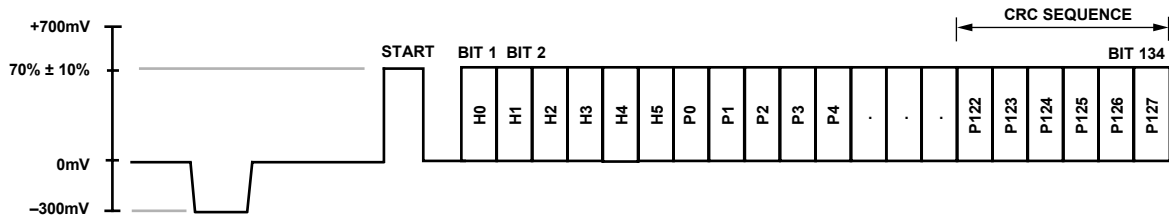

Figure 97. High Definition (1080i) CGMS Waveform

06234-097



NOTES
1. PLEASE REFER TO THE CEA-805-A SPECIFICATION FOR TIMING INFORMATION.

Figure 98. Enhanced Definition (525p) CGMS Type B Waveform

06234-098

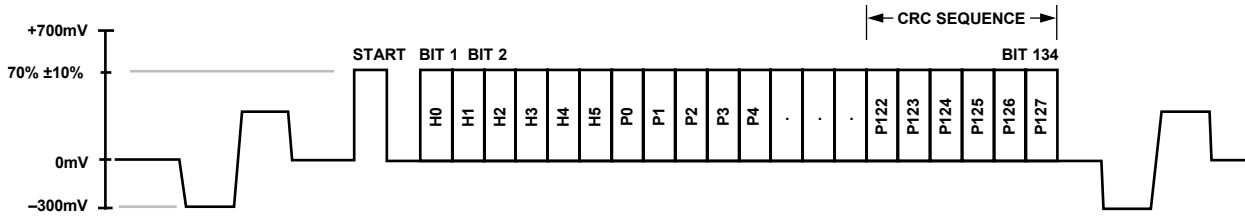

NOTES
1. PLEASE REFER TO THE CEA-805-A SPECIFICATION FOR TIMING INFORMATION.

Figure 99. High Definition (720p and 1080i) CGMS Type B Waveform

06234-099

APPENDIX 2—SD WIDE SCREEN SIGNALING

Subaddress 0x99, Subaddress 0x9A, Subaddress 0x9B

The ADV739x supports wide screen signaling (WSS) conforming to the ETSI 300 294 standard. WSS data is transmitted on Line 23. WSS data can only be transmitted when the device is configured in PAL mode. The WSS data is 14 bits long. The function of each of these bits is shown in Table 54. The WSS data is preceded by a run-in sequence and a start code.

(see Figure 100). The latter portion of Line 23 (after 42.5 μ s from the falling edge of HSYNC) is available for the insertion of video. WSS data transmission on Line 23 can be enabled using Subaddress 0x99, Bit 7. It is possible to blank the WSS portion of Line 23 with Subaddress 0xA1, Bit 7.

Table 54. Function of WSS Bits

Bit Description	Bit Number														Setting
	13	12	11	10	9	8	7	6	5	4	3	2	1	0	
Aspect Ratio, Format, Position											1	0	0	0	4:3, full format, N/A
											0	0	0	1	14:9, letterbox, center
											0	0	1	0	14:9, letterbox, top
											1	0	1	1	16:9, letterbox, center
											0	1	0	0	16:9, letterbox, top
											1	1	0	1	>16:9, letterbox, center
											1	1	1	0	14:9, full format, center
											0	1	1	1	16:0, N/A, N/A
Mode										0					Camera mode
										1					Film mode
Color Encoding									0						Normal PAL
									1						Motion Adaptive ColorPlus
Helper Signals								0							Not present
								1							Present
Reserved						0									
Teletext Subtitles						0									No
						1									Yes
Open Subtitles				0	0										No
				0	1										Subtitles in active image area
				1	0										Subtitles out of active image area
				1	1										Reserved
Surround Sound			0												No
			1												Yes
Copyright		0													No copyright asserted or unknown
		1													Copyright asserted
Copy Protection	0														Copying not restricted
	1														Copying restricted

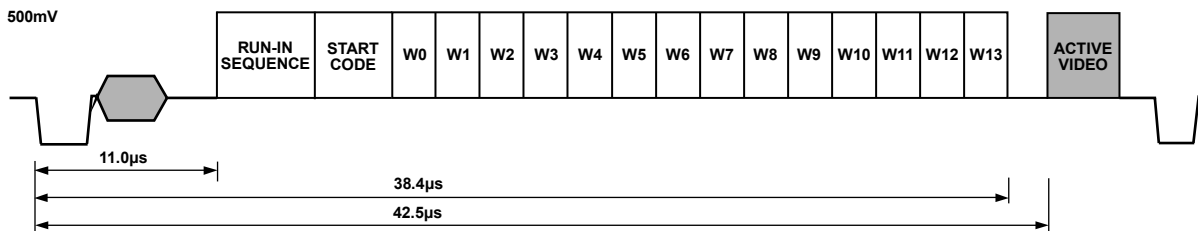

Figure 100. WSS Waveform Diagram

06234-100

APPENDIX 3—SD CLOSED CAPTIONING

Subaddress 0x91 to Subaddress 0x94

The ADV739x supports closed captioning conforming to the standard television synchronizing waveform for color transmission. When enabled, closed captioning is transmitted during the blanked active line time of Line 21 of the odd fields and Line 284 of the even fields. Closed captioning can be enabled using Subaddress 0x83, Bits[6:5].

Closed captioning consists of a 7-cycle sinusoidal burst that is frequency and phase-locked to the caption data. After the clock run-in signal, the blanking level is held for two data bits and is followed by a Logic 1 start bit. Sixteen bits of data follow the start bit. The data consists of two 8-bit bytes (seven data bits, and one odd parity bit per byte). The data for these bytes is stored in SD closed captioning registers (Subaddress 0x93 to Subaddress 0x94).

The ADV739x also supports the extended closed captioning operation, which is active during even fields and encoded on Line 284. The data for this operation is stored in SD closed captioning registers (Subaddress 0x91 to Subaddress 0x92).

The ADV739x automatically generates all clock run-in signals and timing that support closed captioning on Line 21 and Line 284.

All pixels inputs are ignored on Line 21 and Line 284 if closed captioning is enabled.

The FCC Code of Federal Regulations (CFR) Title 47 Section 15.119 and EIA-608 describe the closed captioning information for Line 21 and Line 284.

The ADV739x uses a single buffering method. This means that the closed captioning buffer is only 1-byte deep. Therefore, there is no frame delay in outputting the closed captioning data unlike other 2-byte deep buffering systems. The data must be loaded one line before it is output on Line 21 and Line 284. A typical implementation of this method is to use $\overline{\text{VSYNC}}$ to interrupt a microprocessor, which in turn loads the new data (2 bytes) in every field. If no new data is required for transmission, 0s must be inserted in both data registers; this is called nulling. It is also important to load control codes, all of which are double bytes, on Line 21. Otherwise, a TV does not recognize them. If there is a message such as “Hello World” that has an odd number of characters, it is important to add a blank character at the end to make sure that the end-of-caption, 2-byte control code lands in the same field.

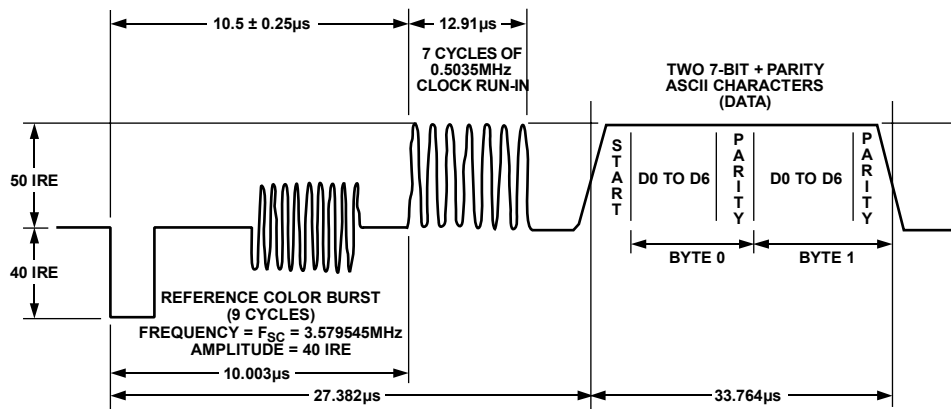

Figure 101. SD Closed Captioning Waveform, NTSC

06234-101

APPENDIX 4—INTERNAL TEST PATTERN GENERATION

SD TEST PATTERNS

The ADV739x is able to generate SD color bar and black bar test patterns.

The register settings in Table 55 are used to generate an SD NTSC 75% color bar test pattern. All other registers are set as normal/default. Component YPrPb output is available on DAC 1 to DAC 3. Upon power-up, the subcarrier frequency registers default to the appropriate values for NTSC.

Table 55. SD NTSC Color Bar Test Pattern Register Writes

Subaddress	Setting
0x00	0x1C
0x82	0xC9
0x84	0x40

For CVBS and S-Video (Y/C) output, 0xCB instead of 0xC9 should be written to Subaddress 0x82.

For component RGB output rather than YPrPb output, 0 should be written to Subaddress 0x02, Bit 5.

To generate an SD NTSC black bar test pattern, the same settings shown in Table 55 should be used with an additional write of 0x24 to Subaddress 0x02.

For PAL output of either test pattern, the same settings are used, except that Subaddress 0x80 is programmed to 0x11 and the subcarrier frequency (F_{sc}) registers are programmed as shown in Table 56.

Table 56. PAL F_{sc} Register Writes

Subaddress	Description	Setting
0x8C	F_{sc0}	0xCB
0x8D	F_{sc1}	0x8A
0x8E	F_{sc2}	0x09
0x8F	F_{sc3}	0x2A

Note that when programming the F_{sc} registers, the user must write the values in the sequence F_{sc0} , F_{sc1} , F_{sc2} , F_{sc3} . The full F_{sc} value to be written is only accepted after the F_{sc3} write is complete.

ED/HD TEST PATTERNS

The ADV739x is able to generate ED/HD color bar, black bar, and hatch test patterns.

The register settings in Table 57 are used to generate an ED 525p hatch test pattern. All other registers are set as normal/default. Component YPrPb output is available on DAC 1 to DAC 3. For component RGB output rather than YPrPb output, 0 should be written to Subaddress 0x02, Bit 5.

Table 57. ED 525p Hatch Test Pattern Register Writes

Subaddress	Setting
0x00	0x1C
0x01	0x10
0x31	0x05

To generate an ED 525p black bar test pattern, the same settings as shown in Table 57 should be used with an additional write of 0x24 to Subaddress 0x02.

To generate an ED 525p flat field test pattern, the same settings shown in Table 57 should be used, except that 0x0D should be written to Subaddress 0x31.

The Y, Cr, and Cb levels for the hatch and flat field test patterns can be controlled using Subaddress 0x36, Subaddress 0x37, and Subaddress 0x38, respectively.

For ED/HD standards other than 525p, the same settings as shown in Table 57 (and subsequent comments) are used except that Subaddress 0x30, Bits[7:3] are updated as appropriate.

APPENDIX 5—SD TIMING

Mode 0 (CCIR-656)—Slave Option (Subaddress 0x8A = XXXXX000)

The ADV739x is controlled by the SAV (start of active video) and EAV (end of active video) time codes embedded in the pixel data. All timing information is transmitted using a 4-byte synchronization pattern. A synchronization pattern is sent immediately before and after each line during active picture and retrace. If the VSYNC and HSYNC pins are not used, they should be tied high when using this mode.

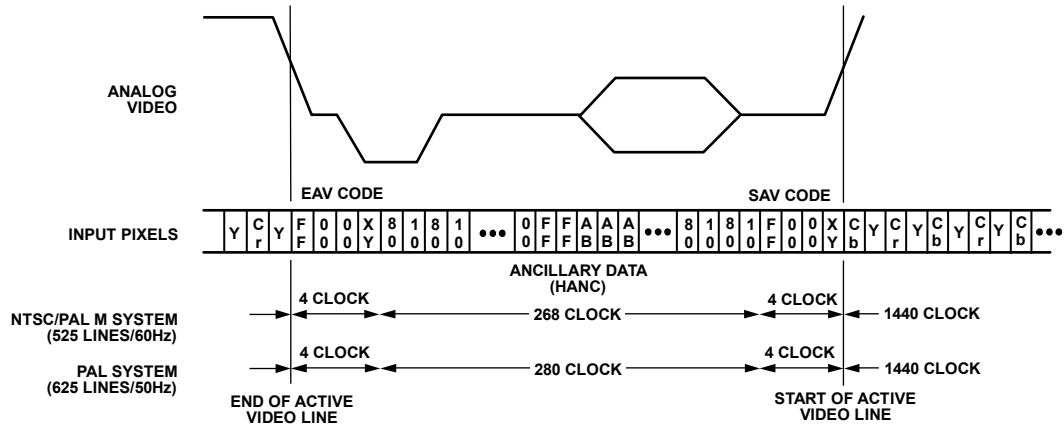

Figure 102. SD Timing Mode 0, Slave Option

06234-102

Mode 0 (CCIR-656)—Master Option (Subaddress 0x8A = XXXXX001)

The ADV739x generates H and F signals required for the SAV and EAV time codes in the CCIR-656 standard. The H bit is output on HSYNC and the F bit is output on VSYNC.

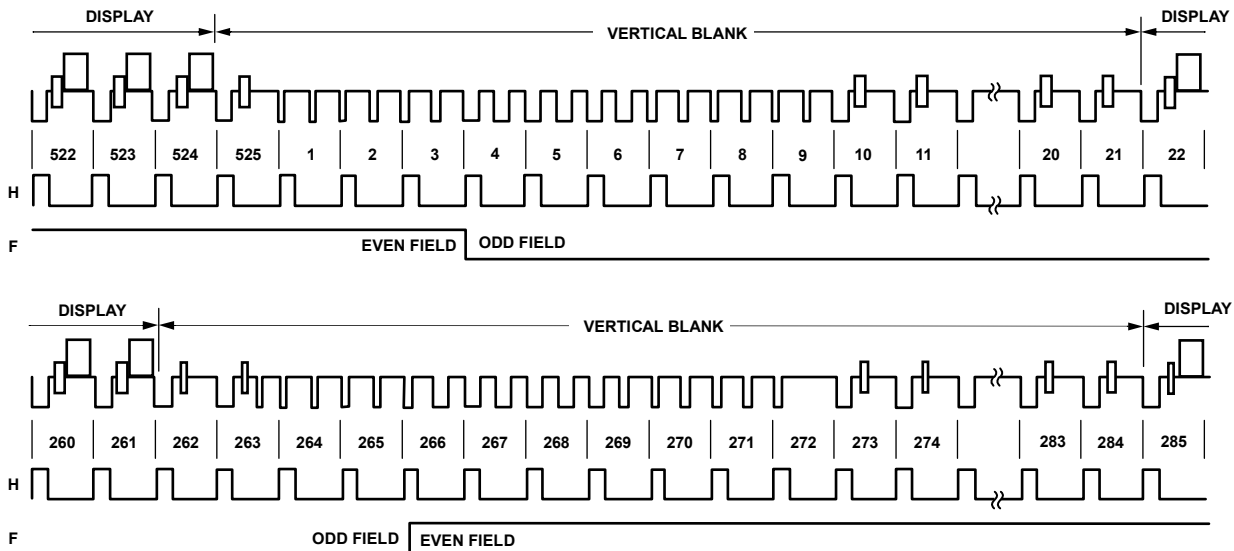

Figure 103. SD Timing Mode 0, Master Option, NTSC

06234-103

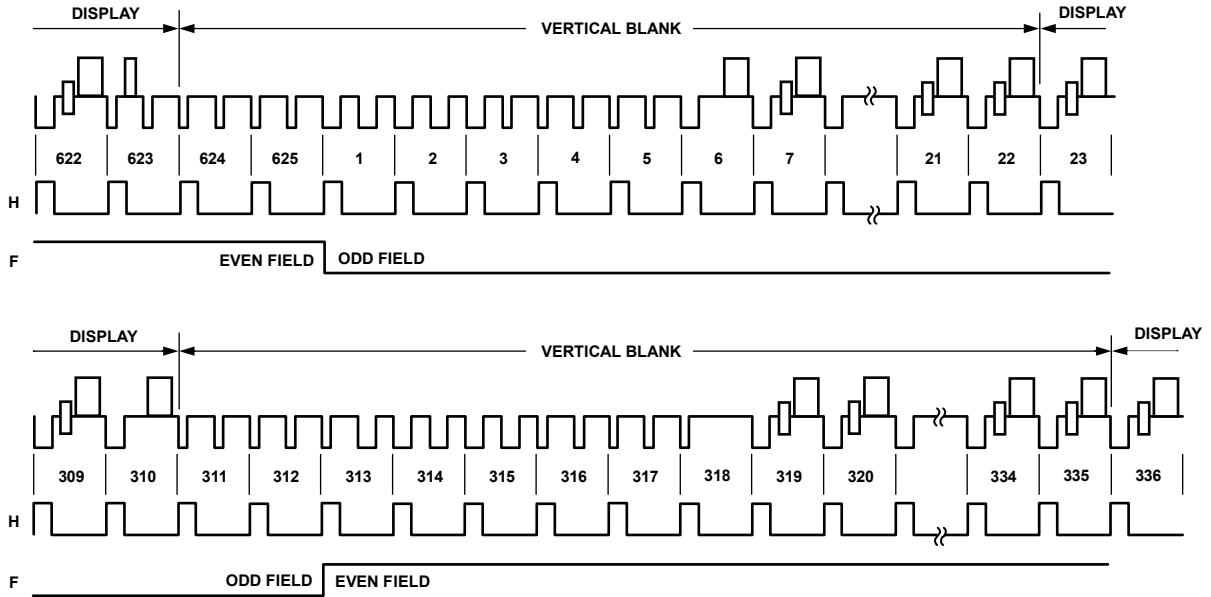

Figure 104. SD Timing Mode 0, Master Option, PAL

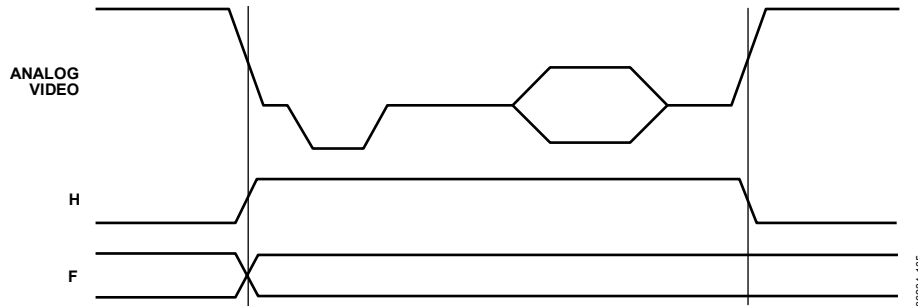

Figure 105. SD Timing Mode 0, Master Option, Data Transitions

Mode 1—Slave Option (Subaddress 0x8A = XXXXX010)

In this mode, the ADV739x accepts horizontal synchronization and odd/even field signals. When $\overline{\text{HSYNC}}$ is low, a transition of the field input indicates a new frame, that is, vertical retrace. The ADV739x automatically blanks all normally blank lines as per CCIR-624. $\overline{\text{HSYNC}}$ and FIELD are input on the $\overline{\text{HSYNC}}$ and $\overline{\text{VSYNC}}$ pins, respectively.

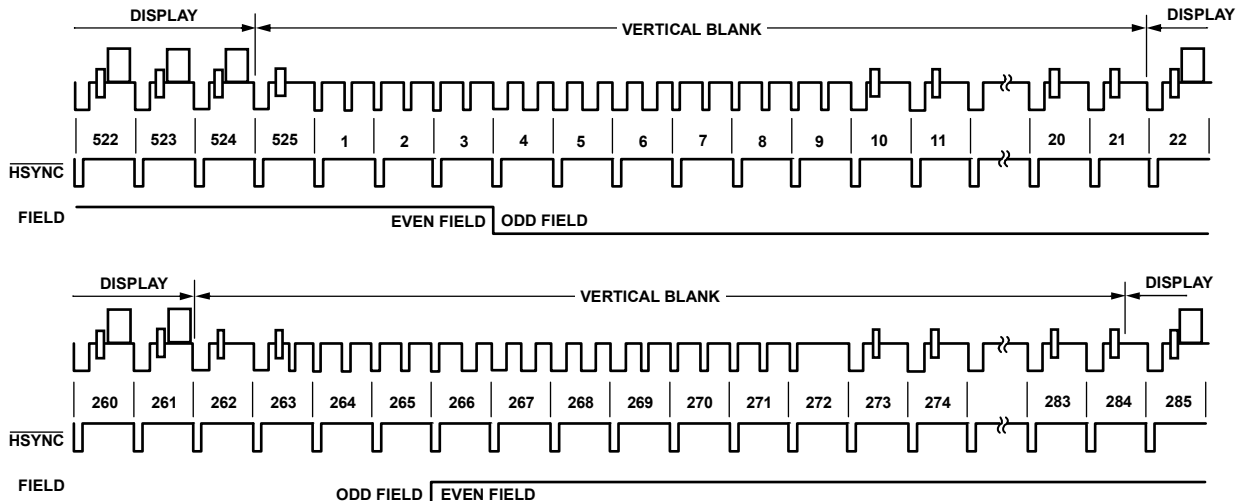

Figure 106. SD Timing Mode 1, Slave Option, NTSC

ADV7390/ADV7391/ADV7392/ADV7393

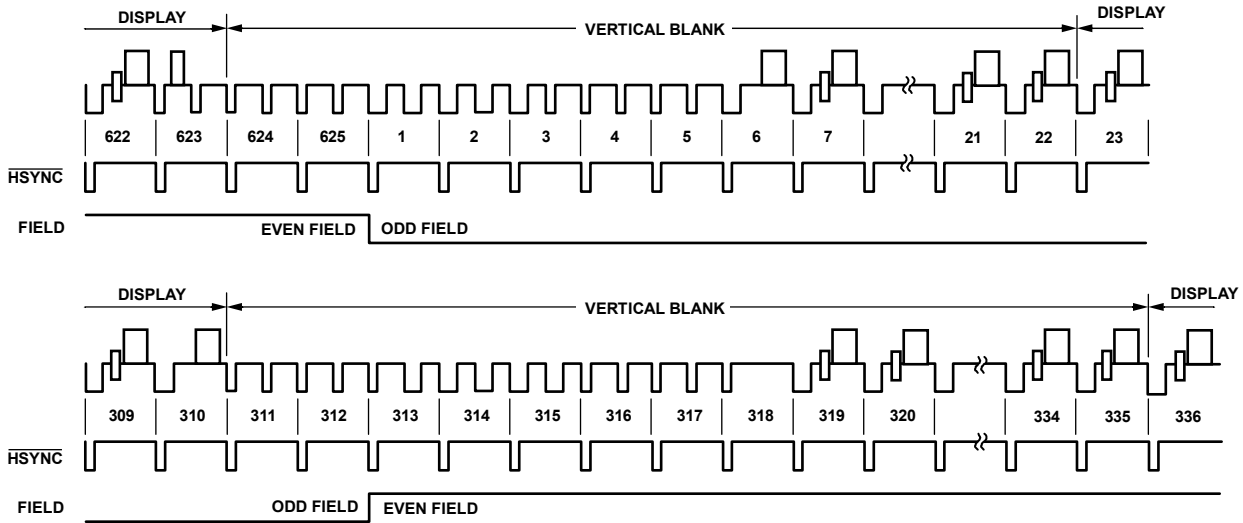

Figure 107. SD Timing Mode 1, Slave Option, PAL

06234-107

Mode 1—Master Option (Subaddress 0x8A = XXXXX 0 1 1)

In this mode, the ADV739x can generate horizontal synchronization and odd/even field signals. When $\overline{\text{HSYNC}}$ is low, a transition of the field input indicates a new frame, that is, vertical retrace. The ADV739x automatically blanks all normally blank lines as per CCIR-624. Pixel data is latched on the rising clock edge following the timing signal transitions. $\overline{\text{HSYNC}}$ and $\overline{\text{FIELD}}$ are output on the $\overline{\text{HSYNC}}$ and $\overline{\text{VSYNC}}$ pins, respectively.

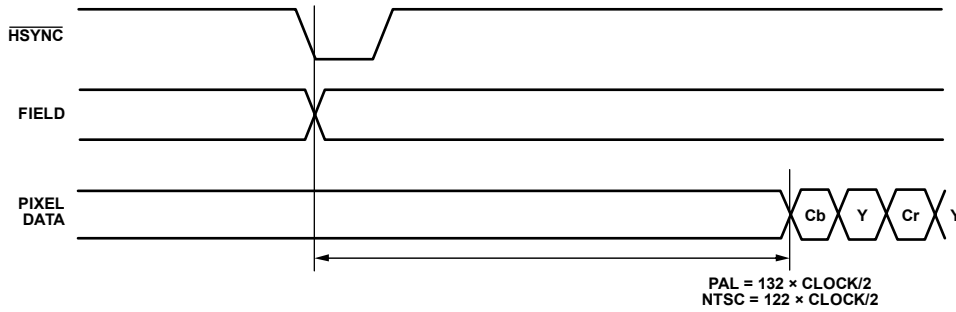

Figure 108. SD Timing Mode 1, Odd/Even Field Transitions (Master/Slave)

06234-108

Mode 2—Slave Option (Subaddress 0x8A = XXXXX 1 0 0)

In this mode, the ADV739x accepts horizontal and vertical synchronization signals. A coincident low transition of both $\overline{\text{HSYNC}}$ and $\overline{\text{VSYNC}}$ inputs indicates the start of an odd field. A $\overline{\text{VSYNC}}$ low transition when $\overline{\text{HSYNC}}$ is high indicates the start of an even field. The ADV739x automatically blanks all normally blank lines as per CCIR-624. $\overline{\text{HSYNC}}$ and $\overline{\text{VSYNC}}$ are input on the $\overline{\text{HSYNC}}$ and $\overline{\text{VSYNC}}$ pins, respectively.

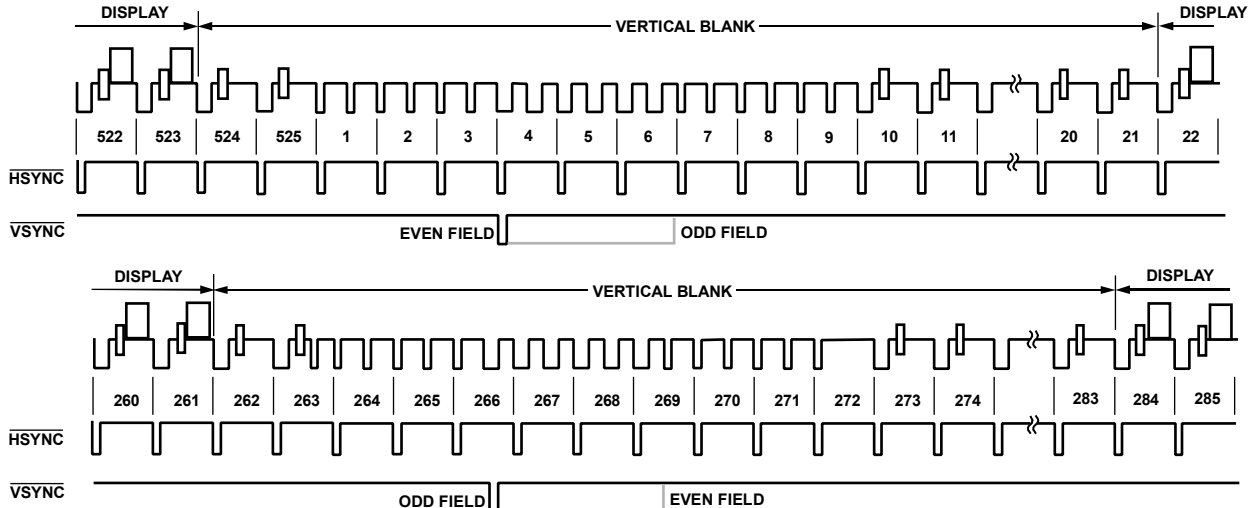

Figure 109. SD Timing Mode 2, Slave Option, NTSC

06234-109

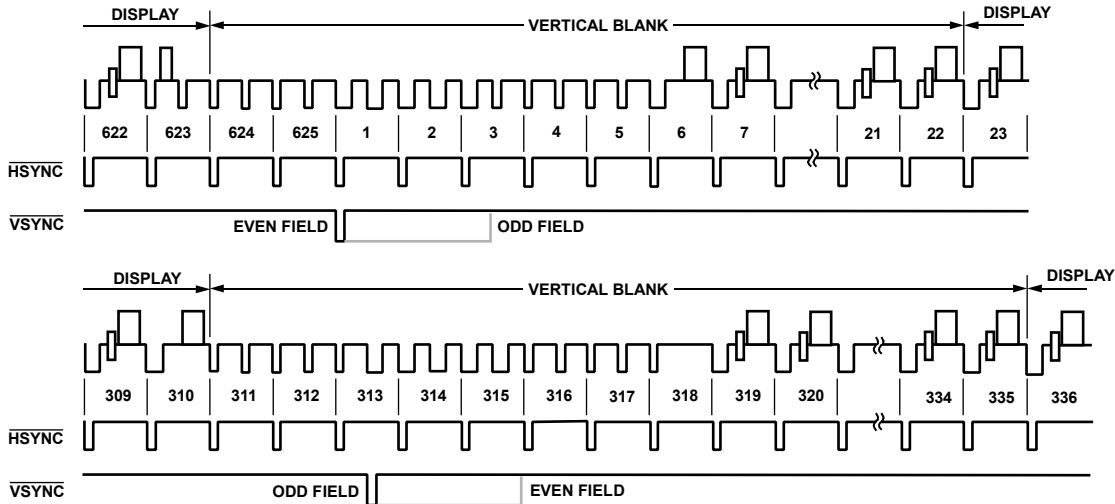

Figure 110. SD Timing Mode 2, Slave Option, PAL

06234-110

Mode 2—Master Option (Subaddress 0x8A = XXXXX 1 0 1)

In this mode, the ADV739x can generate horizontal and vertical synchronization signals. A coincident low transition of both $\overline{\text{HSYNC}}$ and $\overline{\text{VSYNC}}$ inputs indicates the start of an odd field.

A $\overline{\text{VSYNC}}$ low transition when $\overline{\text{HSYNC}}$ is high indicates the start of an even field. The ADV739x automatically blanks all normally blank lines as per CCIR-624. $\overline{\text{HSYNC}}$ and $\overline{\text{VSYNC}}$ are output on the $\overline{\text{HSYNC}}$ and $\overline{\text{VSYNC}}$ pins, respectively.

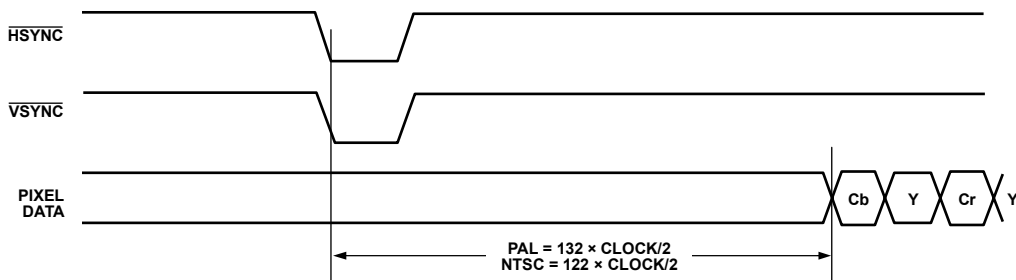

Figure 111. SD Timing Mode 2, Even-to-Odd Field Transition (Master/Slave)

06234-111

ADV7390/ADV7391/ADV7392/ADV7393

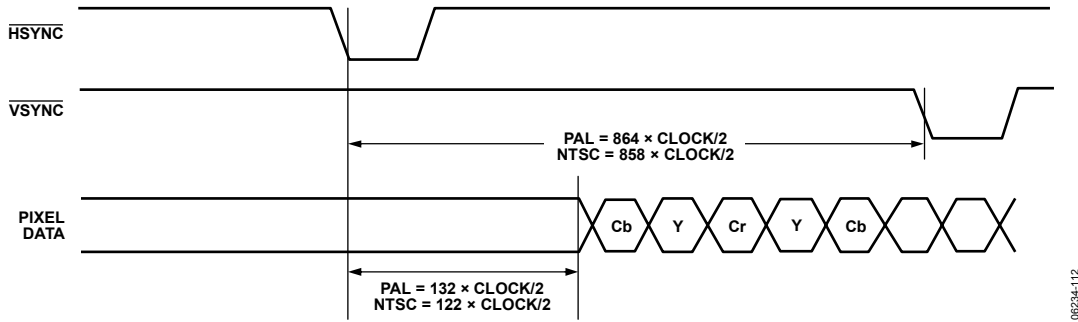

Figure 112. SD Timing Mode 2, Odd-to-Even Field Transition (Master/Slave)

Mode 3—Master/Slave Option (Subaddress 0x8A = XXXXX110 or XXXXX111)

In this mode, the ADV739x accepts or generates horizontal synchronization and odd/even field signals. When $\overline{\text{HSYNC}}$ is high, a transition of the field input indicates a new frame, that is, vertical retrace. The ADV739x automatically blanks all normally blank lines as per CCIR-624. $\overline{\text{HSYNC}}$ and $\overline{\text{VSYNC}}$ are output in master mode and input in slave mode on the $\overline{\text{HSYNC}}$ and $\overline{\text{VSYNC}}$ pins, respectively.

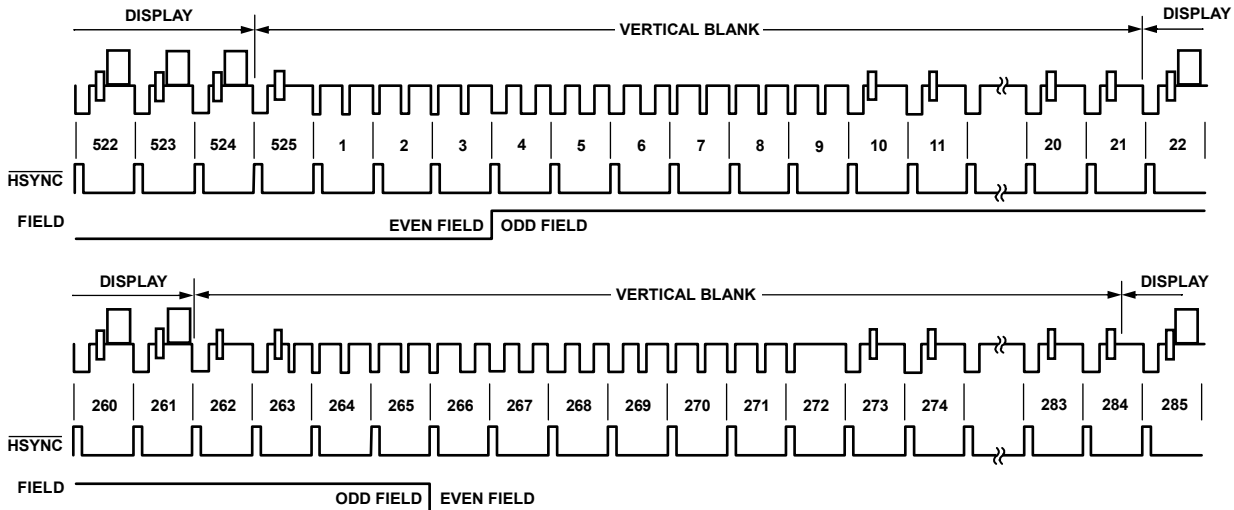

Figure 113. SD Timing Mode 3, NTSC

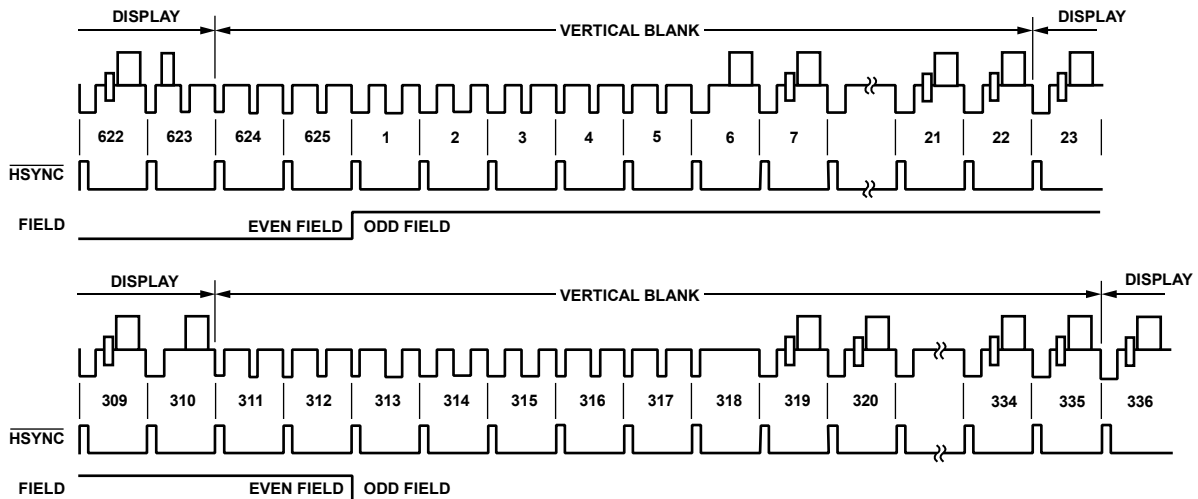

Figure 114. SD Timing Mode 3, PAL

APPENDIX 6—HD TIMING

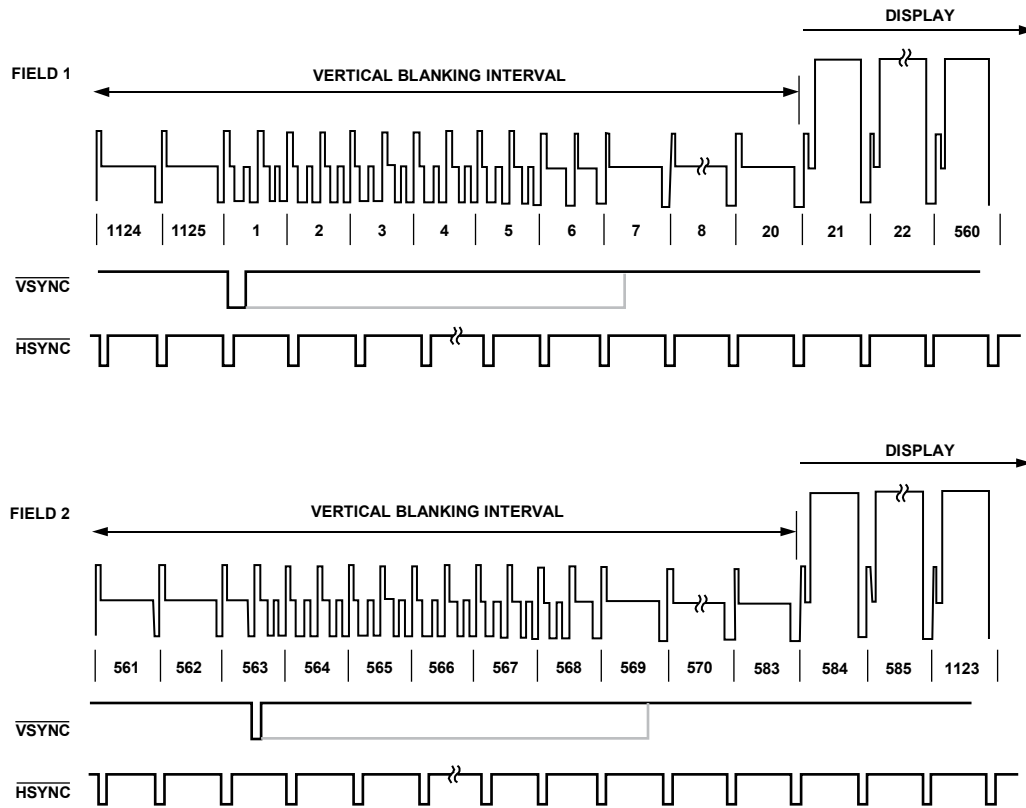

Figure 115. 1080i $\overline{\text{HSYNC}}$ and $\overline{\text{VSYNC}}$ Input Timing

06234-115

APPENDIX 7—VIDEO OUTPUT LEVELS

SD YPrPb OUTPUT LEVELS—SMPTE/EBU N10

Pattern: 100% Color Bars

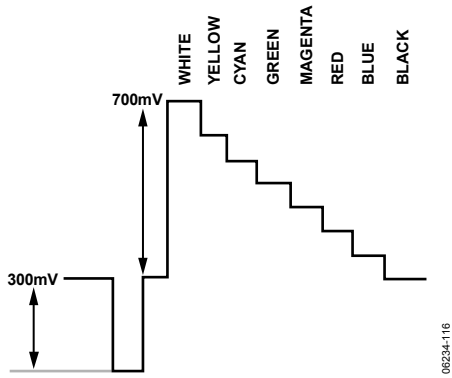

Figure 116. Y Levels—NTSC

06234-116

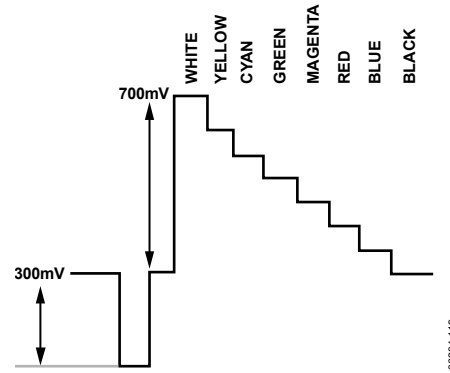

Figure 119. Y Levels—PAL

06234-119

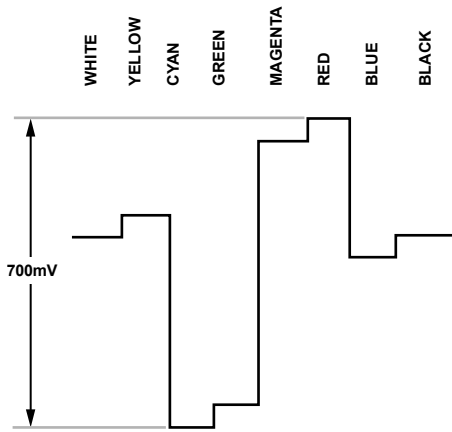

Figure 117. Pr Levels—NTSC

06234-117

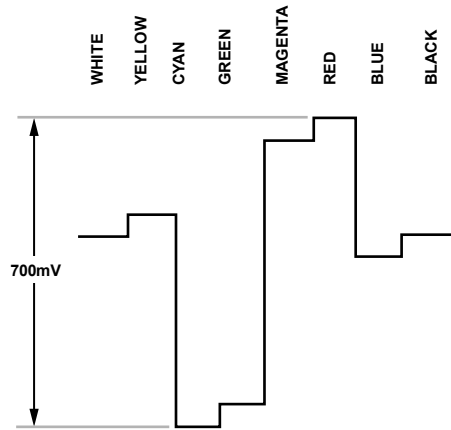

Figure 120. Pr Levels—PAL

06234-120

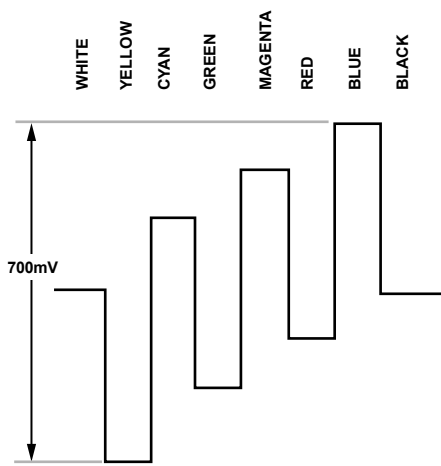

Figure 118. Pb Levels—NTSC

06234-118

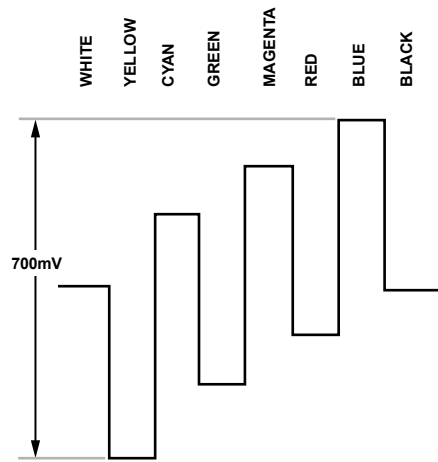

Figure 121. Pb Levels—PAL

06234-121

ED/HD YPrPb OUTPUT LEVELS

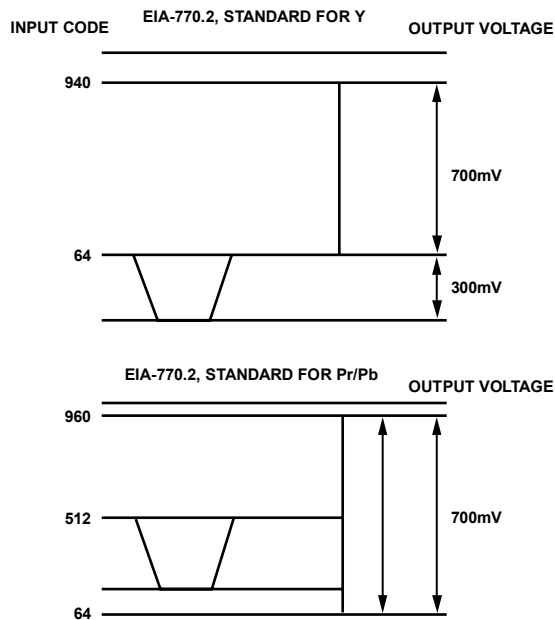

Figure 122. EIA-770.2 Standard Output Signals (525p/625p)

06234-122

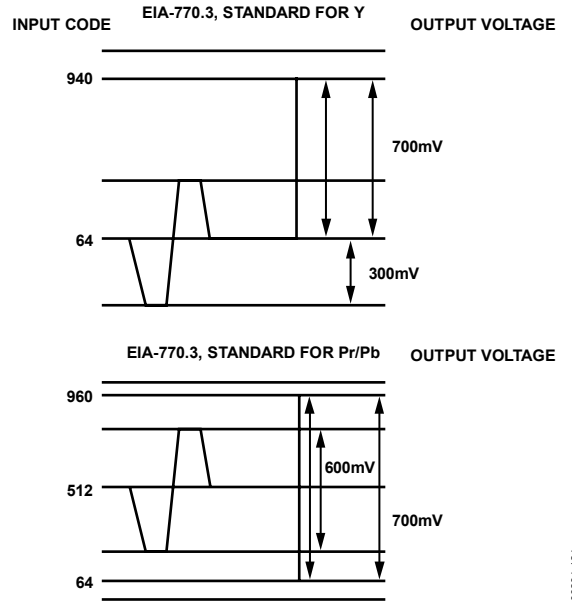

Figure 124. EIA-770.3 Standard Output Signals (1080i/720p)

06234-124

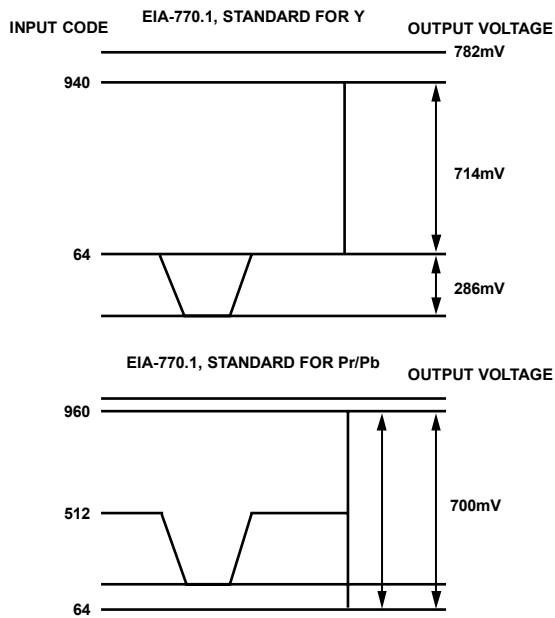

Figure 123. EIA-770.1 Standard Output Signals (525p/625p)

06234-123

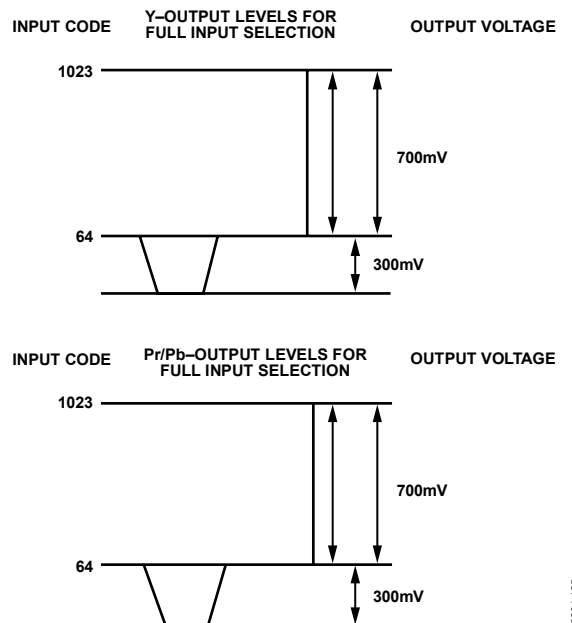

Figure 125. Output Levels for Full Input Selection

06234-125

ADV7390/ADV7391/ADV7392/ADV7393

SD/ED/HD RGB OUTPUT LEVELS

Pattern: 100%/75% Color Bars

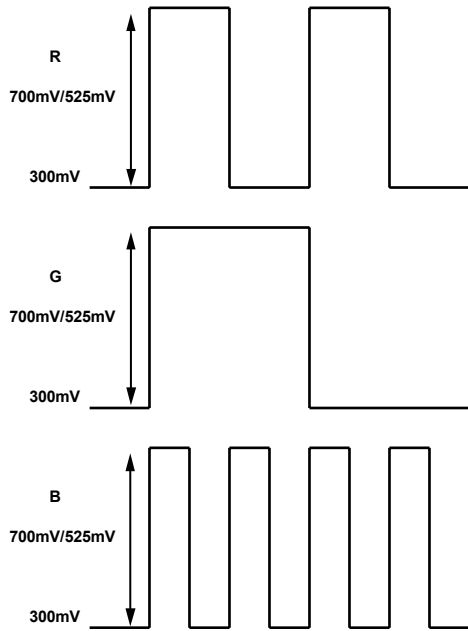

Figure 126. SD/ED RGB Output Levels—RGB Sync Disabled

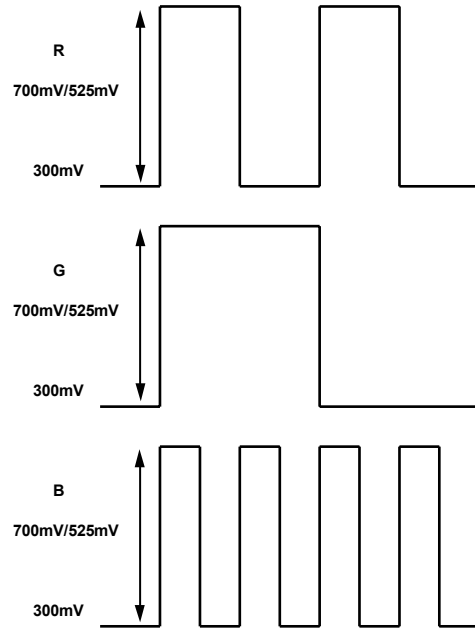

Figure 128. HD RGB Output Levels—RGB Sync Disabled

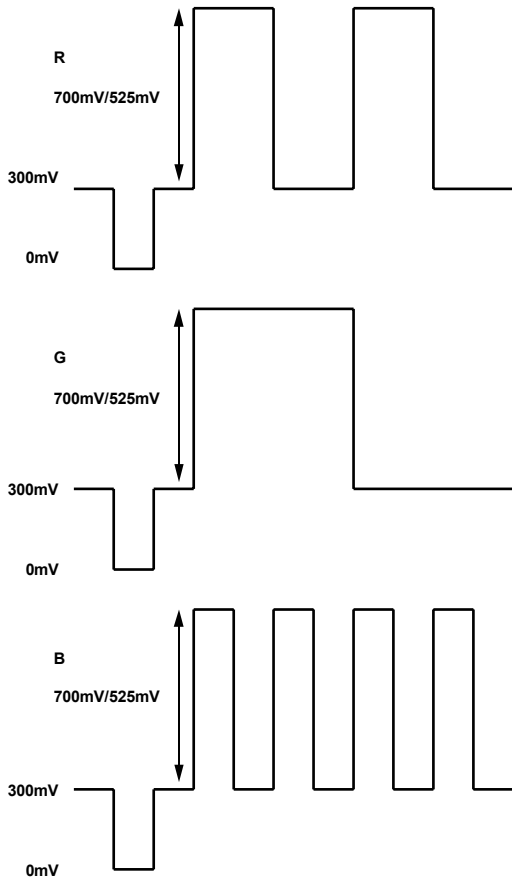

Figure 127. SD/ED RGB Output Levels—RGB Sync Enabled

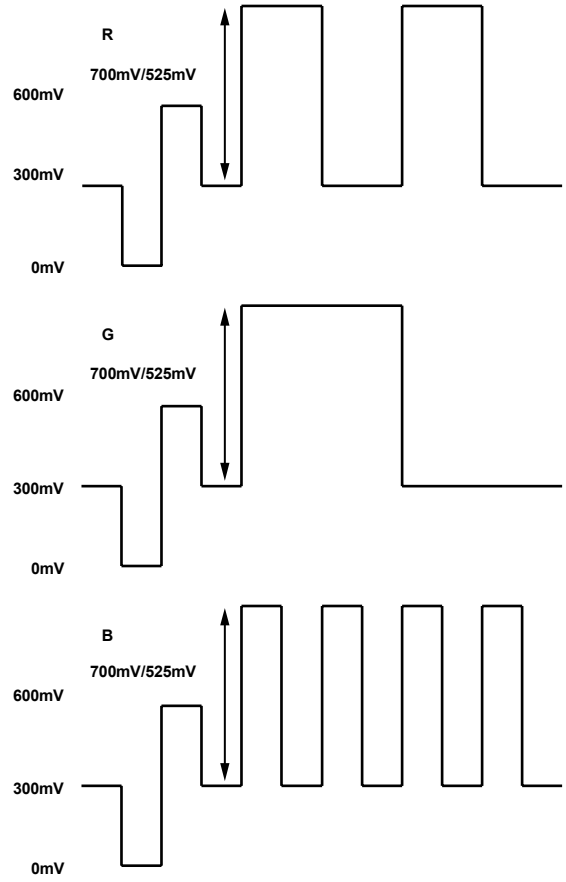
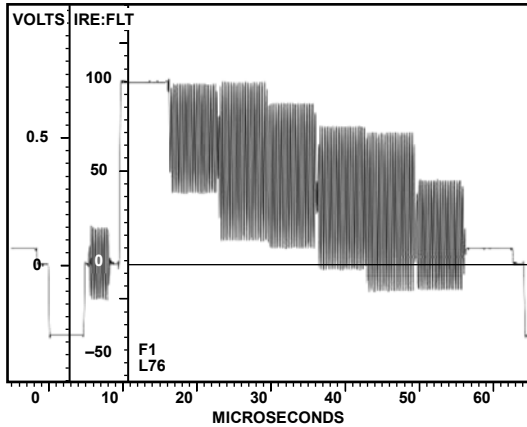

Figure 129. HD RGB Output Levels—RGB Sync Enabled

06234-127

06234-129

SD OUTPUT PLOTS



APL = 44.5%
525 LINE NTSC
SLOW CLAMP TO 0.00V AT 6.72µs

PRECISION MODE OFF
SYNCHRONOUS SYNC = A
FRAMES SELECTED 1, 2

Figure 130. NTSC Color Bars (75%)

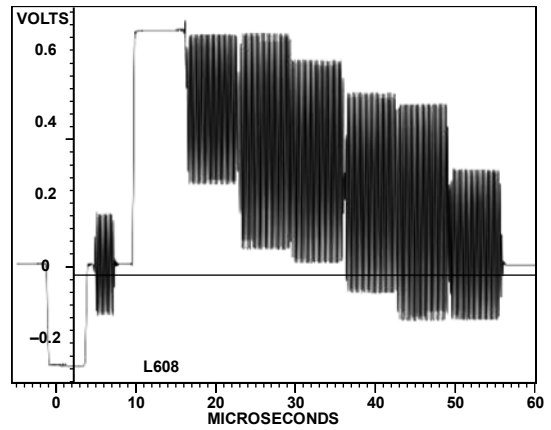

NOISE REDUCTION: 0.00dB
APL = 39.1%
625 LINE NTSC NO FILTERING
SLOW CLAMP TO 0.00 AT 6.72µs

PRECISION MODE OFF
SYNCHRONOUS SOUND-IN-SYNC OFF
FRAMES SELECTED 1, 2, 3, 4

Figure 133. PAL Color Bars (75%)

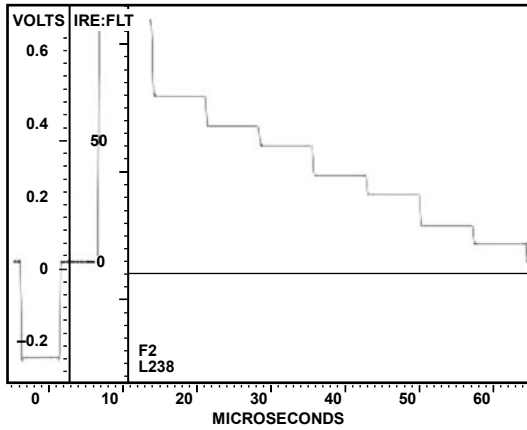

NOISE REDUCTION: 15.05dB
APL = 44.3%
525 LINE NTSC NO FILTERING
SLOW CLAMP TO 0.00V AT 6.72µs

PRECISION MODE OFF
SYNCHRONOUS SYNC = SOURCE
FRAMES SELECTED 1, 2

Figure 131. NTSC Luma

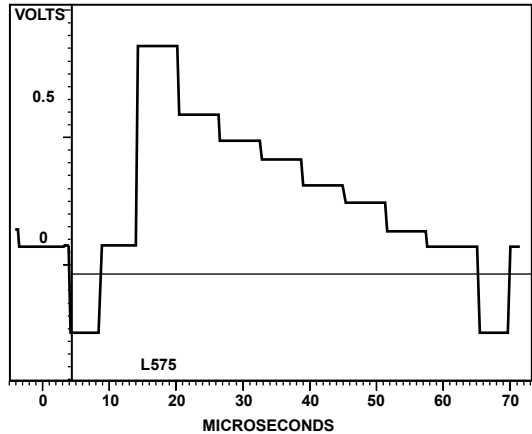

APL NEEDS SYNC SOURCE. NO BUNCH SIGNAL
625 LINE PAL NO FILTERING
SLOW CLAMP TO 0.00 AT 6.72µs

PRECISION MODE OFF
SYNCHRONOUS SOUND-IN-SYNC OFF
FRAMES SELECTED 1

Figure 134. PAL Luma

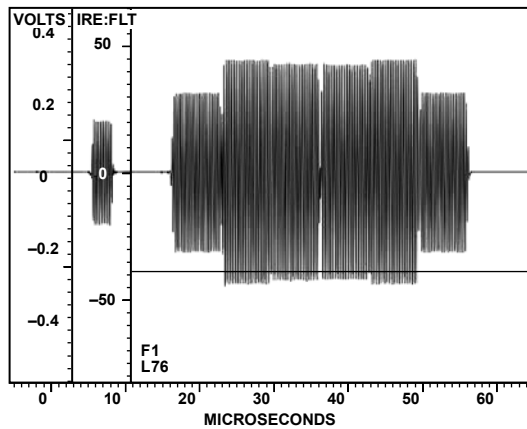

NOISE REDUCTION: 15.05dB
APL NEEDS SYNC SOURCE.
525 LINE NTSC NO FILTERING
SLOW CLAMP TO 0.00 AT 6.72µs

PRECISION MODE OFF
SYNCHRONOUS SYNC = B
FRAMES SELECTED 1, 2

Figure 132. NTSC Chroma

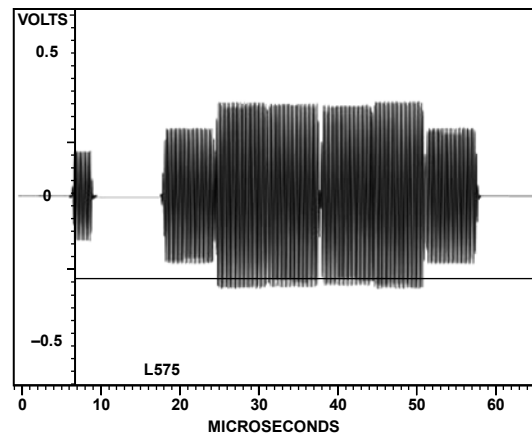

APL NEEDS SYNC SOURCE. NO BUNCH SIGNAL
625 LINE PAL NO FILTERING
SLOW CLAMP TO 0.00 AT 6.72µs

PRECISION MODE OFF
SYNCHRONOUS SOUND-IN-SYNC OFF
FRAMES SELECTED 1

Figure 135. PAL Chroma

APPENDIX 8—VIDEO STANDARDS

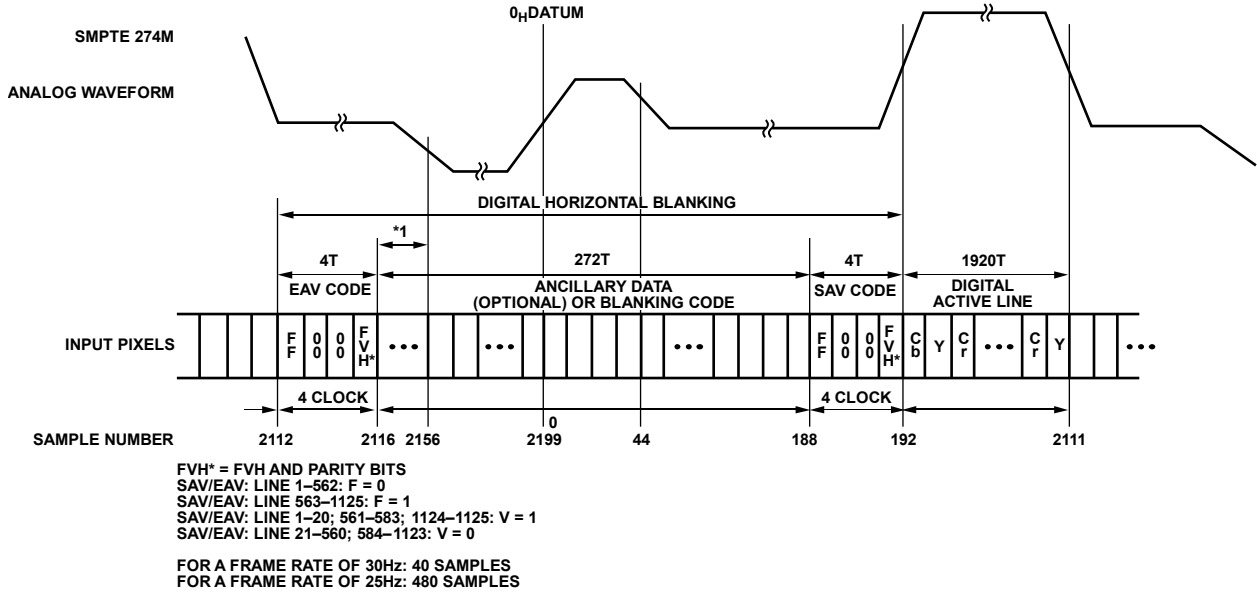

Figure 136. EAV/SAV Input Data Timing Diagram (SMPTE 274M)

08234-136

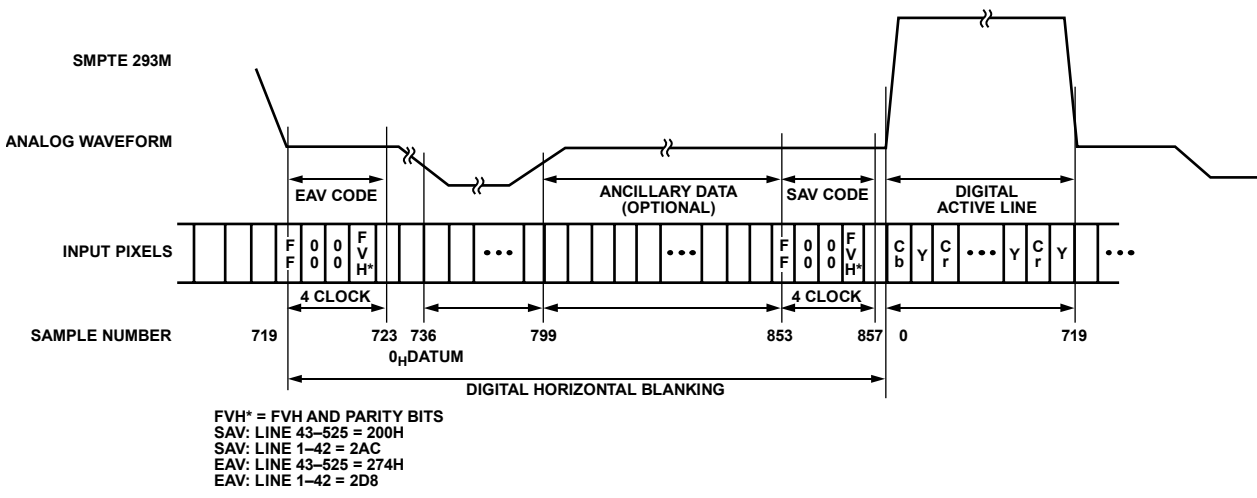

Figure 137. EAV/SAV Input Data Timing Diagram (SMPTE 293M)

08234-137

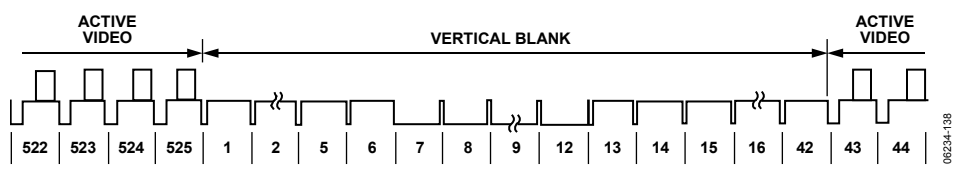

Figure 138. SMPTE 293M (525p)

08234-138

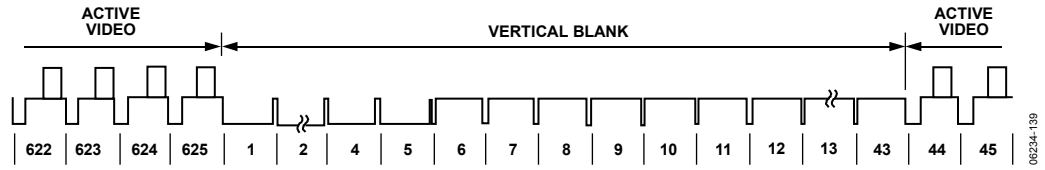

Figure 139. ITU-R BT.1358 (625p)

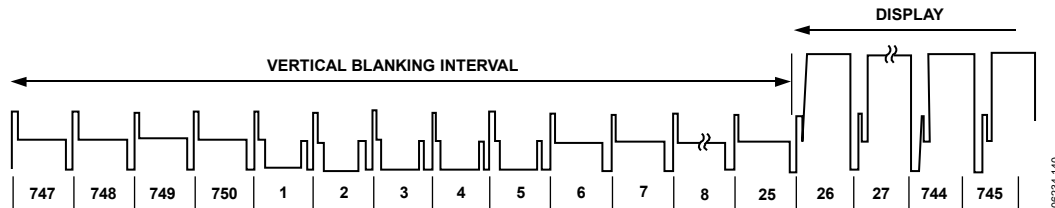

Figure 140. SMPTE 296M (720p)

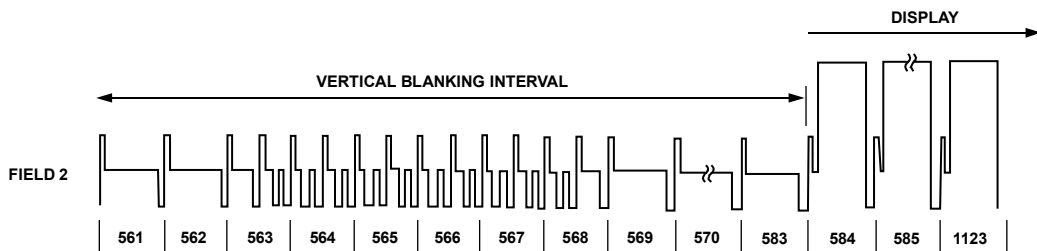
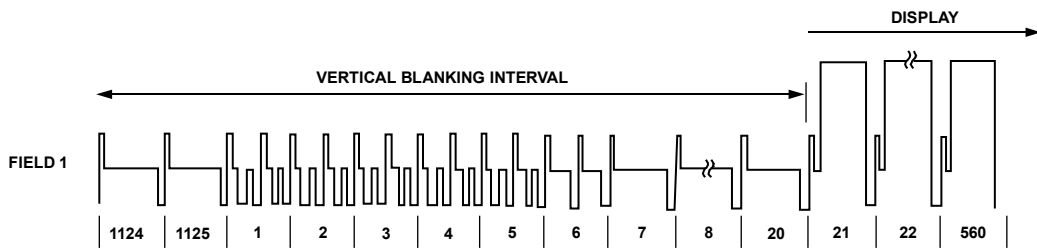

Figure 141. SMPTE 274M (1080i)

APPENDIX 9—CONFIGURATION SCRIPTS

The scripts listed in the following pages can be used to configure the ADV739x for basic operation. Certain features are enabled by default. If required for a specific application, further features can be enabled. Table 58 lists the scripts available for SD modes of operation. Similarly, Table 89 and Table 106 list the scripts available for ED and HD modes of operation, respectively.

STANDARD DEFINITION

Table 58. SD Configuration Scripts

Input Format	Input Data Width	Synchronization Format	Input Color Space	Output Color Space	Table Number
525i (NTSC)	8-Bit SDR	EAV/SAV	YCrCb	YPrPb	Table 59
525i (NTSC)	8-Bit SDR	EAV/SAV	YCrCb	CVBS/Y-C (S-Video)	Table 60
525i (NTSC)	8-Bit SDR	$\overline{\text{HSYNC}}/\overline{\text{VSYNC}}$	YCrCb	YPrPb	Table 61
525i (NTSC)	8-Bit SDR	EAV/SAV	YCrCb	RGB	Table 62
525i (NTSC)	8-Bit SDR	$\overline{\text{HSYNC}}/\overline{\text{VSYNC}}$	YCrCb	RGB	Table 63
525i (NTSC)	10-Bit SDR	EAV/SAV	YCrCb	YPrPb	Table 64
525i (NTSC)	10-Bit SDR	$\overline{\text{HSYNC}}/\overline{\text{VSYNC}}$	YCrCb	YPrPb	Table 65
525i (NTSC)	10-Bit SDR	$\overline{\text{HSYNC}}/\overline{\text{VSYNC}}$	YCrCb	CVBS/Y-C (S-Video)	Table 66
525i (NTSC)	10-Bit SDR	EAV/SAV	YCrCb	RGB	Table 67
525i (NTSC)	10-Bit SDR	$\overline{\text{HSYNC}}/\overline{\text{VSYNC}}$	YCrCb	RGB	Table 68
525i (NTSC)	16-Bit SDR	$\overline{\text{HSYNC}}/\overline{\text{VSYNC}}$	YCrCb	YPrPb	Table 69
525i (NTSC)	16-Bit SDR	$\overline{\text{HSYNC}}/\overline{\text{VSYNC}}$	YCrCb	RGB	Table 70
525i (NTSC)	16-Bit SDR	$\overline{\text{HSYNC}}/\overline{\text{VSYNC}}$	RGB	YPrPb	Table 71
525i (NTSC)	16-Bit SDR	$\overline{\text{HSYNC}}/\overline{\text{VSYNC}}$	RGB	CVBS/Y-C (S-Video)	Table 72
525i (NTSC)	16-Bit SDR	$\overline{\text{HSYNC}}/\overline{\text{VSYNC}}$	RGB	RGB	Table 73
625i (PAL)	8-Bit SDR	EAV/SAV	YCrCb	YPrPb	Table 74
625i (PAL)	8-Bit SDR	EAV/SAV	YCrCb	CVBS/Y-C (S-Video)	Table 75
625i (PAL)	8-Bit SDR	$\overline{\text{HSYNC}}/\overline{\text{VSYNC}}$	YCrCb	YPrPb	Table 76
625i (PAL)	8-Bit SDR	EAV/SAV	YCrCb	RGB	Table 77
625i (PAL)	8-Bit SDR	$\overline{\text{HSYNC}}/\overline{\text{VSYNC}}$	YCrCb	RGB	Table 78
625i (PAL)	10-Bit SDR	EAV/SAV	YCrCb	YPrPb	Table 79
625i (PAL)	10-Bit SDR	$\overline{\text{HSYNC}}/\overline{\text{VSYNC}}$	YCrCb	YPrPb	Table 80
625i (PAL)	10-Bit SDR	$\overline{\text{HSYNC}}/\overline{\text{VSYNC}}$	YCrCb	CVBS/Y-C (S-Video)	Table 81
625i (PAL)	10-Bit SDR	EAV/SAV	YCrCb	RGB	Table 82
625i (PAL)	10-Bit SDR	$\overline{\text{HSYNC}}/\overline{\text{VSYNC}}$	YCrCb	RGB	Table 83
625i (PAL)	16-Bit SDR	$\overline{\text{HSYNC}}/\overline{\text{VSYNC}}$	YCrCb	YPrPb	Table 84
625i (PAL)	16-Bit SDR	$\overline{\text{HSYNC}}/\overline{\text{VSYNC}}$	YCrCb	RGB	Table 85
625i (PAL)	16-Bit SDR	$\overline{\text{HSYNC}}/\overline{\text{VSYNC}}$	RGB	YPrPb	Table 86
625i (PAL)	16-Bit SDR	$\overline{\text{HSYNC}}/\overline{\text{VSYNC}}$	RGB	CVBS/Y-C (S-Video)	Table 87
625i (PAL)	16-Bit SDR	$\overline{\text{HSYNC}}/\overline{\text{VSYNC}}$	RGB	RGB	Table 88

Table 59. 8-Bit 525i YCrCb In (EAV/SAV), YPrPb Out

Subaddress	Setting	Description
0x17	0x02	Software reset.
0x00	0x1C	All DACs enabled. PLL enabled (16x).
0x01	0x00	SD input mode.
0x80	0x10	NTSC standard. SSAF luma filter enabled. 1.3 MHz chroma filter enabled.
0x82	0xC9	Pixel data valid. YPrPb out. SSAF PrPb filter enabled. Active video edge control enabled. Pedestal enabled.

Table 60. 8-Bit 525i YCrCb In (EAV/SAV), CVBS/Y-C Out

Subaddress	Setting	Description
0x17	0x02	Software reset
0x00	0x1C	All DACs enabled. PLL enabled (16x).
0x01	0x00	SD input mode.
0x80	0x10	NTSC standard. SSAF luma filter enabled. 1.3 MHz chroma filter enabled.
0x82	0xCB	Pixel data valid. CVBS/S-Video out. SSAF PrPb filter enabled. Active video edge control enabled. Pedestal enabled.

Table 61. 8-Bit 525i YCrCb In, YPrPb Out

Subaddress	Setting	Description
0x17	0x02	Software reset.
0x00	0x1C	All DACs enabled. PLL enabled (16x).
0x01	0x00	SD input mode.
0x80	0x10	NTSC standard. SSAF luma filter enabled. 1.3 MHz chroma filter enabled.
0x82	0xC9	Pixel data valid. YPrPb out. SSAF PrPb filter enabled. Active video edge control enabled. Pedestal enabled.
0x8A	0x0C	Timing Mode 2 (Slave). HSYNC/VSYNC synchronization.

Table 62. 8-Bit 525i YCrCb In (EAV/SAV), RGB Out

Subaddress	Setting	Description
0x17	0x02	Software reset.
0x00	0x1C	All DACs enabled. PLL enabled (16x).
0x01	0x00	SD input mode.
0x02	0x10	RGB output enabled. RGB output sync enabled.
0x80	0x10	NTSC standard. SSAF luma filter enabled. 1.3 MHz chroma filter enabled.
0x82	0xC9	Pixel data valid. YPrPb out. SSAF PrPb filter enabled. Active video edge control enabled. Pedestal enabled.

Table 63. 8-Bit 525i YCrCb In, RGB Out

Subaddress	Setting	Description
0x17	0x02	Software reset.
0x00	0x1C	All DACs enabled. PLL enabled (16x).
0x01	0x00	SD input mode.
0x02	0x10	RGB output enabled. RGB output sync enabled.
0x80	0x10	NTSC standard. SSAF luma filter enabled. 1.3 MHz chroma filter enabled.
0x82	0xC9	Pixel data valid. YPrPb out. SSAF PrPb filter enabled. Active video edge control enabled. Pedestal enabled.
0x8A	0x0C	Timing Mode 2 (Slave). HSYNC/VSYNC synchronization.

Table 64. 10-Bit 525i YCrCb In (EAV/SAV), YPrPb Out

Subaddress	Setting	Description
0x17	0x02	Software reset.
0x00	0x1C	All DACs enabled. PLL enabled (16x).
0x01	0x00	SD input mode.
0x80	0x10	NTSC standard. SSAF luma filter enabled. 1.3 MHz chroma filter enabled.
0x82	0xC9	Pixel data valid. YPrPb out. SSAF PrPb filter enabled. Active video edge control enabled. Pedestal enabled.
0x88	0x10	10-bit input enabled.

Table 65. 10-Bit 525i YCrCb In, YPrPb Out

Subaddress	Setting	Description
0x17	0x02	Software reset.
0x00	0x1C	All DACs enabled. PLL enabled (16x).
0x01	0x00	SD input mode.
0x80	0x10	NTSC standard. SSAF luma filter enabled. 1.3 MHz chroma filter enabled.
0x82	0xC9	Pixel data valid. YPrPb out. SSAF PrPb filter enabled. Active video edge control enabled. Pedestal enabled.
0x88	0x10	10-bit input enabled.
0x8A	0x0C	Timing Mode 2 (Slave). HSYNC/VSYNC synchronization.

Table 66. 10-Bit 525i YCrCb In, CVBS/Y-C Out

Subaddress	Setting	Description
0x17	0x02	Software reset.
0x00	0x1C	All DACs enabled. PLL enabled (16x).
0x01	0x00	SD input mode.
0x80	0x10	NTSC standard. SSAF luma filter enabled. 1.3 MHz chroma filter enabled.
0x82	0xCB	Pixel data valid. CVBS/S-Video out. SSAF PrPb filter enabled. Active video edge control enabled. Pedestal enabled.
0x88	0x10	10-bit input enabled.
0x8A	0x0C	Timing Mode 2 (Slave). HSYNC/VSYNC synchronization.

ADV7390/ADV7391/ADV7392/ADV7393

Table 67. 10-Bit 525i YCrCb In (EAV/SAV), RGB Out

Subaddress	Setting	Description
0x17	0x02	Software reset.
0x00	0x1C	All DACs enabled. PLL enabled (16x).
0x01	0x00	SD input mode.
0x02	0x10	RGB output enabled. RGB output sync enabled.
0x80	0x10	NTSC standard. SSAF luma filter enabled. 1.3 MHz chroma filter enabled.
0x82	0xC9	Pixel data valid. YPrPb out. SSAF PrPb filter enabled. Active video edge control enabled. Pedestal enabled.
0x88	0x10	10-bit input enabled.

Table 68. 10-Bit 525i YCrCb In, RGB Out

Subaddress	Setting	Description
0x17	0x02	Software reset.
0x00	0x1C	All DACs enabled. PLL enabled (16x).
0x01	0x00	SD input mode.
0x02	0x10	RGB output enabled. RGB output sync enabled.
0x80	0x10	NTSC standard. SSAF luma filter enabled. 1.3 MHz chroma filter enabled.
0x82	0xC9	Pixel data valid. YPrPb out. SSAF PrPb filter enabled. Active video edge control enabled. Pedestal enabled.
0x88	0x10	10-bit input enabled.
0x8A	0x0C	Timing Mode 2 (Slave). HSYNC/VSYNC synchronization.

Table 69. 16-Bit 525i YCrCb In, YPrPb Out

Subaddress	Setting	Description
0x17	0x02	Software reset.
0x00	0x1C	All DACs enabled. PLL enabled (16x).
0x01	0x00	SD input mode.
0x80	0x10	NTSC standard. SSAF luma filter enabled. 1.3 MHz chroma filter enabled.
0x82	0xC9	Pixel data valid. YPrPb out. SSAF PrPb filter enabled. Active video edge control enabled. pedestal enabled.
0x88	0x08	16-bit input enabled.
0x8A	0x0C	Timing Mode 2 (Slave). HSYNC/VSYNC synchronization.

Table 70. 16-Bit 525i YCrCb In, RGB Out

Subaddress	Setting	Description
0x17	0x02	Software reset.
0x00	0x1C	All DACs enabled. PLL enabled (16x).
0x01	0x00	SD input mode.
0x02	0x10	RGB output enabled. RGB output sync enabled.
0x80	0x10	NTSC standard. SSAF luma filter enabled. 1.3 MHz chroma filter enabled.
0x82	0xC9	Pixel data valid. YPrPb out. SSAF PrPb filter enabled. Active video edge control enabled. Pedestal enabled.
0x88	0x08	16-bit input enabled.
0x8A	0x0C	Timing Mode 2 (Slave). HSYNC/VSYNC synchronization.

Table 71. 16-Bit 525i RGB In, YPrPb Out

Subaddress	Setting	Description
0x17	0x02	Software reset.
0x00	0x1C	All DACs enabled. PLL enabled (16x).
0x01	0x00	SD input mode.
0x80	0x10	NTSC standard. SSAF luma filter enabled. 1.3 MHz chroma filter enabled.
0x82	0xC9	Pixel data valid. YPrPb out. SSAF PrPb filter enabled. Active video edge control enabled. Pedestal enabled.
0x87	0x80	RGB input enabled.
0x88	0x08	16-bit input enabled.
0x8A	0x0C	Timing Mode 2 (Slave). HSYNC/VSYNC synchronization.

Table 72. 16-Bit 525i RGB In, CVBS/Y-C Out

Subaddress	Setting	Description
0x17	0x02	Software reset.
0x00	0x1C	All DACs enabled. PLL enabled (16x).
0x01	0x00	SD input mode.
0x80	0x10	NTSC standard. SSAF luma filter enabled. 1.3 MHz chroma filter enabled.
0x82	0xCB	Pixel data valid. CVBS/S-Video out. SSAF PrPb filter enabled. Active video edge control enabled. Pedestal enabled.
0x87	0x80	RGB input enabled.
0x88	0x08	16-bit input enabled.
0x8A	0x0C	Timing Mode 2 (Slave). HSYNC/VSYNC synchronization.

Table 73. 16-Bit 525i RGB In, RGB Out

Subaddress	Setting	Description
0x17	0x02	Software reset.
0x00	0x1C	All DACs enabled. PLL enabled (16x).
0x01	0x00	SD input mode.
0x02	0x10	RGB output enabled. RGB output sync enabled.
0x80	0x10	NTSC standard. SSAF luma filter enabled. 1.3 MHz chroma filter enabled.
0x82	0xC9	Pixel data valid. YPrPb out. SSAF PrPb filter enabled. Active video edge control enabled. Pedestal enabled.
0x87	0x80	RGB input enabled.
0x88	0x08	16-bit input enabled.
0x8A	0x0C	Timing Mode 2 (Slave). HSYNC/VSYNC synchronization.

Table 74. 8-Bit 625i YCrCb In (EAV/SAV), YPrPb Out

Subaddress	Setting	Description
0x17	0x02	Software reset.
0x00	0x1C	All DACs enabled. PLL enabled (16x).
0x01	0x00	SD input mode.
0x80	0x11	PAL standard. SSAF luma filter enabled. 1.3 MHz chroma filter enabled.
0x82	0xC1	Pixel data valid. YPrPb out. SSAF PrPb filter enabled. Active video edge control enabled.
0x8C	0xCB	PAL F _{SC} value.
0x8D	0x8A	PAL F _{SC} value.
0x8E	0x09	PAL F _{SC} value.
0x8F	0x2A	PAL F _{SC} value.

Table 75. 8-Bit 625i YCrCb In (EAV/SAV), CVBS/Y-C Out

Subaddress	Setting	Description
0x17	0x02	Software reset.
0x00	0x1C	All DACs enabled. PLL enabled (16x).
0x01	0x00	SD input mode.
0x80	0x11	PAL standard. SSAF luma filter enabled. 1.3 MHz chroma filter enabled.
0x82	0xC3	Pixel data valid. CVBS/S-Video out. SSAF PrPb filter enabled. Active video edge control enabled.
0x8C	0xCB	PAL F _{SC} value.
0x8D	0x8A	PAL F _{SC} value.
0x8E	0x09	PAL F _{SC} value.
0x8F	0x2A	PAL F _{SC} value.

Table 76. 8-Bit 625i YCrCb In, YPrPb Out

Subaddress	Setting	Description
0x17	0x02	Software reset.
0x00	0x1C	All DACs enabled. PLL enabled (16x).
0x01	0x00	SD input mode.
0x80	0x11	PAL standard. SSAF luma filter enabled. 1.3 MHz chroma filter enabled.
0x82	0xC1	Pixel data valid. YPrPb out. SSAF PrPb filter enabled. Active video edge control enabled.
0x8A	0x0C	Timing Mode 2 (Slave). HSYNC/VSYNC synchronization.
0x8C	0xCB	PAL F _{SC} value.
0x8D	0x8A	PAL F _{SC} value.
0x8E	0x09	PAL F _{SC} value.
0x8F	0x2A	PAL F _{SC} value.

Table 77. 8-Bit 625i YCrCb In (EAV/SAV), RGB Out

Subaddress	Setting	Description
0x17	0x02	Software reset.
0x00	0x1C	All DACs enabled. PLL enabled (16x).
0x01	0x00	SD input mode.
0x02	0x10	RGB output enabled. RGB output sync enabled.
0x80	0x11	PAL standard. SSAF luma filter enabled. 1.3 MHz chroma filter enabled.
0x82	0xC1	Pixel data valid. YPrPb out. SSAF PrPb filter enabled. Active video edge control enabled.
0x8C	0xCB	PAL F _{SC} value.
0x8D	0x8A	PAL F _{SC} value.
0x8E	0x09	PAL F _{SC} value.
0x8F	0x2A	PAL F _{SC} value.

Table 78. 8-Bit 625i YCrCb In, RGB Out

Subaddress	Setting	Description
0x17	0x02	Software reset.
0x00	0x1C	All DACs enabled. PLL enabled (16x).
0x01	0x00	SD input mode.
0x02	0x10	RGB output enabled. RGB output sync enabled.
0x80	0x11	PAL standard. SSAF luma filter enabled. 1.3 MHz chroma filter enabled.
0x82	0xC1	Pixel data valid. YPrPb out. SSAF PrPb filter enabled. Active video edge control enabled.
0x8A	0x0C	Timing Mode 2 (Slave). HSYNC/VSYNC synchronization.
0x8C	0xCB	PAL F _{SC} value.
0x8D	0x8A	PAL F _{SC} value.
0x8E	0x09	PAL F _{SC} value.
0x8F	0x2A	PAL F _{SC} value.

ADV7390/ADV7391/ADV7392/ADV7393

Table 79. 10-Bit 625i YCrCb In (EAV/SAV), YPrPb Out

Subaddress	Setting	Description
0x17	0x02	Software reset.
0x00	0x1C	All DACs enabled. PLL enabled (16x).
0x01	0x00	SD input mode.
0x80	0x11	PAL standard. SSAF luma filter enabled. 1.3 MHz chroma filter enabled.
0x82	0xC1	Pixel data valid. YPrPb out. SSAF PrPb filter enabled. Active video edge control enabled.
0x88	0x10	10-bit input enabled.

Table 80. 10-Bit 625i YCrCb In, YPrPb Out

Subaddress	Setting	Description
0x17	0x02	Software reset.
0x00	0x1C	All DACs enabled. PLL enabled (16x).
0x01	0x00	SD input mode.
0x80	0x11	PAL standard. SSAF luma filter enabled. 1.3 MHz chroma filter enabled.
0x82	0xC1	Pixel data valid. YPrPb out. SSAF PrPb filter enabled. Active video edge control enabled.
0x88	0x10	10-bit input enabled.
0x8A	0x0C	Timing Mode 2 (Slave). HSYNC/VSYNC synchronization.
0x8C	0xCB	PAL F _{SC} value.
0x8D	0x8A	PAL F _{SC} value.
0x8E	0x09	PAL F _{SC} value.
0x8F	0x2A	PAL F _{SC} value.

Table 81. 10-Bit 625i YCrCb In, CVBS/Y-C Out

Subaddress	Setting	Description
0x17	0x02	Software reset.
0x00	0x1C	All DACs enabled. PLL enabled (16x).
0x01	0x00	SD input mode.
0x80	0x11	PAL standard. SSAF luma filter enabled. 1.3 MHz chroma filter enabled.
0x82	0xC3	Pixel Data Valid. CVBS/S-Video Out. SSAF PrPb Filter Enabled. Active Video Edge Control Enabled.
0x88	0x10	10-bit input enabled.
0x8A	0x0C	Timing Mode 2 (Slave). HSYNC/VSYNC synchronization.
0x8C	0xCB	PAL F _{SC} value.
0x8D	0x8A	PAL F _{SC} value.
0x8E	0x09	PAL F _{SC} value.
0x8F	0x2A	PAL F _{SC} value.

Table 82. 10-Bit 625i YCrCb In (EAV/SAV), RGB Out

Subaddress	Setting	Description
0x17	0x02	Software reset.
0x00	0x1C	All DACs enabled. PLL enabled (16x).
0x01	0x00	SD input mode.
0x02	0x10	RGB output enabled. RGB output sync enabled.
0x80	0x11	PAL standard. SSAF luma filter enabled. 1.3 MHz chroma filter enabled.
0x82	0xC1	Pixel data valid. YPrPb out. SSAF PrPb filter enabled. Active video edge control enabled.
0x88	0x10	10-bit input enabled.
0x8C	0xCB	PAL F _{SC} value.
0x8D	0x8A	PAL F _{SC} value.
0x8E	0x09	PAL F _{SC} value.
0x8F	0x2A	PAL F _{SC} value.

Table 83. 10-Bit 625i YCrCb In, RGB Out

Subaddress	Setting	Description
0x17	0x02	Software reset.
0x00	0x1C	All DACs enabled. PLL enabled (16x).
0x01	0x00	SD input mode.
0x02	0x10	RGB output enabled. RGB output sync enabled.
0x80	0x11	PAL standard. SSAF luma filter enabled. 1.3 MHz chroma filter enabled.
0x82	0xC1	Pixel data valid. YPrPb out. SSAF PrPb filter enabled. Active video edge control enabled.
0x88	0x10	10-bit input enabled.
0x8A	0x0C	Timing Mode 2 (Slave). HSYNC/VSYNC synchronization.
0x8C	0xCB	PAL F _{SC} value.
0x8D	0x8A	PAL F _{SC} value.
0x8E	0x09	PAL F _{SC} value.
0x8F	0x2A	PAL F _{SC} value.

Table 84. 16-Bit 625i YCrCb In, YPrPb Out

Subaddress	Setting	Description
0x17	0x02	Software reset.
0x00	0x1C	All DACs enabled. PLL enabled (16x).
0x01	0x00	SD input mode.
0x80	0x11	PAL standard. SSAF luma filter enabled. 1.3 MHz chroma filter enabled.
0x82	0xC1	Pixel data valid. YPrPb out. SSAF PrPb filter enabled. Active video edge control enabled.
0x88	0x08	16-bit input enabled.
0x8A	0x0C	Timing Mode 2 (Slave). HSYNC/VSYNC synchronization.
0x8C	0xCB	PAL F _{SC} value.
0x8D	0x8A	PAL F _{SC} value.
0x8E	0x09	PAL F _{SC} value.
0x8F	0x2A	PAL F _{SC} value.

Table 85. 16-Bit 625i YCrCb In, RGB Out

Subaddress	Setting	Description
0x17	0x02	Software reset.
0x00	0x1C	All DACs enabled. PLL enabled (16x).
0x01	0x00	SD input mode.
0x02	0x10	RGB output enabled. RGB output sync enabled.
0x80	0x11	PAL standard. SSAF luma filter enabled. 1.3 MHz chroma filter enabled.
0x82	0xC1	Pixel data valid. YPrPb out. SSAF PrPb filter enabled. Active video edge control enabled.
0x88	0x08	16-bit input enabled.
0x8A	0x0C	Timing Mode 2 (Slave). HSYNC/VSYNC synchronization.
0x8C	0xCB	PAL F _{SC} value.
0x8D	0x8A	PAL F _{SC} value.
0x8E	0x09	PAL F _{SC} value.
0x8F	0x2A	PAL F _{SC} value.

Table 86. 16-Bit 625i RGB In, YPrPb Out

Subaddress	Setting	Description
0x17	0x02	Software reset.
0x00	0x1C	All DACs enabled. PLL enabled (16x).
0x01	0x00	SD input mode.
0x80	0x11	PAL standard. SSAF luma filter enabled. 1.3 MHz chroma filter enabled.
0x82	0xC1	Pixel data valid. YPrPb out. SSAF PrPb filter enabled. Active video edge control enabled.
0x87	0x80	RGB input enabled.
0x88	0x08	16-bit input enabled.
0x8A	0x0C	Timing Mode 2 (Slave). HSYNC/VSYNC synchronization.
0x8C	0xCB	PAL F _{SC} value.
0x8D	0x8A	PAL F _{SC} value.
0x8E	0x09	PAL F _{SC} value.
0x8F	0x2A	PAL F _{SC} value.

Table 87. 16-Bit 625i RGB In, CVBS/Y-C Out

Subaddress	Setting	Description
0x17	0x02	Software reset.
0x00	0x1C	All DACs enabled. PLL enabled (16x).
0x01	0x00	SD input mode.
0x80	0x11	PAL standard. SSAF luma filter enabled. 1.3 MHz chroma filter enabled.
0x82	0xC3	Pixel data valid. CVBS/S-Video out. SSAF PrPb filter enabled. Active video edge control enabled.
0x87	0x80	RGB input enabled.
0x88	0x08	16-bit input enabled.
0x8A	0x0C	Timing Mode 2 (Slave). HSYNC/VSYNC synchronization.
0x8C	0xCB	PAL F _{SC} value.
0x8D	0x8A	PAL F _{SC} value.
0x8E	0x09	PAL F _{SC} value.
0x8F	0x2A	PAL F _{SC} value.

Table 88. 16-Bit 625i RGB In, RGB Out

Subaddress	Setting	Description
0x17	0x02	Software reset.
0x00	0x1C	All DACs enabled. PLL enabled (16x).
0x01	0x00	SD input mode.
0x02	0x10	RGB output enabled. RGB output sync enabled.
0x80	0x11	PAL standard. SSAF luma filter enabled. 1.3 MHz chroma filter enabled.
0x82	0xC1	Pixel data valid. YPrPb out. SSAF PrPb filter enabled. Active video edge control enabled.
0x87	0x80	RGB input enabled.
0x88	0x08	16-bit input enabled.
0x8A	0x0C	Timing Mode 2 (Slave). HSYNC/VSYNC synchronization.
0x8C	0xCB	PAL F _{SC} value.
0x8D	0x8A	PAL F _{SC} value.
0x8E	0x09	PAL F _{SC} value.
0x8F	0x2A	PAL F _{SC} value.

ADV7390/ADV7391/ADV7392/ADV7393

ENHANCED DEFINITION

Table 89. ED Configuration Scripts

Input Format	Input Data Width	Synchronization Format	Input Color Space	Output Color Space	Table Number
525p	8-Bit DDR	EAV/SAV	YCrCb	YPrPb	Table 98
525p	8-Bit DDR	EAV/SAV	YCrCb	RGB	Table 100
525p	10-Bit DDR	EAV/SAV	YCrCb	YPrPb	Table 99
525p	10-Bit DDR	EAV/SAV	YCrCb	RGB	Table 101
525p	16-Bit SDR	EAV/SAV	YCrCb	YPrPb	Table 90
525p	16-Bit SDR	$\overline{\text{HSYNC}}/\overline{\text{VSYNC}}$	YCrCb	YPrPb	Table 91
525p	16-Bit SDR	EAV/SAV	YCrCb	RGB	Table 92
525p	16-Bit SDR	$\overline{\text{HSYNC}}/\overline{\text{VSYNC}}$	YCrCb	RGB	Table 93
625p	8-Bit DDR	EAV/SAV	YCrCb	YPrPb	Table 102
625p	8-Bit DDR	EAV/SAV	YCrCb	RGB	Table 104
625p	10-Bit DDR	EAV/SAV	YCrCb	YPrPb	Table 103
625p	10-Bit DDR	EAV/SAV	YCrCb	RGB	Table 105
625p	16-Bit SDR	EAV/SAV	YCrCb	YPrPb	Table 94
625p	16-Bit SDR	$\overline{\text{HSYNC}}/\overline{\text{VSYNC}}$	YCrCb	YPrPb	Table 95
625p	16-Bit SDR	EAV/SAV	YCrCb	RGB	Table 96
625p	16-Bit SDR	$\overline{\text{HSYNC}}/\overline{\text{VSYNC}}$	YCrCb	RGB	Table 97

Table 90. 16-Bit 525p YCrCb In (EAV/SAV), YPrPb Out

Subaddress	Setting	Description
0x17	0x02	Software reset.
0x00	0x1C	All DACs enabled. PLL enabled (8x).
0x01	0x10	ED-SDR input mode.
0x30	0x04	525p @ 59.94 Hz. EAV/SAV synchronization. EIA-770.2 output levels.
0x31	0x01	Pixel data valid.

Table 91. 16-Bit 525p YCrCb In, YPrPb Out

Subaddress	Setting	Description
0x17	0x02	Software reset.
0x00	0x1C	All DACs enabled. PLL enabled (8x).
0x01	0x10	ED-SDR input mode.
0x30	0x00	525p @ 59.94 Hz. $\overline{\text{HSYNC}}/\overline{\text{VSYNC}}$ synchronization. EIA-770.2 output levels.
0x31	0x01	Pixel data valid.

Table 92. 16-Bit 525p YCrCb In (EAV/SAV), RGB Out

Subaddress	Setting	Description
0x17	0x02	Software reset.
0x00	0x1C	All DACs enabled. PLL enabled (8x).
0x01	0x10	ED-SDR input mode.
0x02	0x10	RGB output enabled. RGB output sync enabled.
0x30	0x04	525p @ 59.94 Hz. EAV/SAV synchronization. EIA-770.2 output levels.
0x31	0x01	Pixel data valid.

Table 93. 16-Bit 525p YCrCb In, RGB Out

Subaddress	Setting	Description
0x17	0x02	Software reset.
0x00	0x1C	All DACs enabled. PLL enabled (8x).
0x01	0x10	ED-SDR input mode.
0x02	0x10	RGB output enabled. RGB output sync enabled.
0x30	0x00	525p @ 59.94 Hz. $\overline{\text{HSYNC}}/\overline{\text{VSYNC}}$ synchronization. EIA-770.2 output levels.
0x31	0x01	Pixel data valid.

Table 94. 16-Bit 625p YCrCb In (EAV/SAV), YPrPb Out

Subaddress	Setting	Description
0x17	0x02	Software reset.
0x00	0x1C	All DACs enabled. PLL enabled (8x).
0x01	0x10	ED-SDR input mode.
0x30	0x1C	625p @ 50 Hz. EAV/SAV synchronization. EIA-770.2 output levels.
0x31	0x01	Pixel data valid.

Table 95. 16-Bit 625p YCrCb In, YPrPb Out

Subaddress	Setting	Description
0x17	0x02	Software reset.
0x00	0x1C	All DACs enabled. PLL enabled (8x).
0x01	0x10	ED-SDR input mode.
0x30	0x18	625p @ 50 Hz. $\overline{\text{HSYNC}}/\overline{\text{VSYNC}}$ synchronization. EIA-770.2 output levels.
0x31	0x01	Pixel data valid.

Table 96. 16-Bit 625p YCrCb In (EAV/SAV), RGB Out

Subaddress	Setting	Description
0x17	0x02	Software reset.
0x00	0x1C	All DACs enabled. PLL enabled (8x).
0x01	0x10	ED-SDR input mode.
0x02	0x10	RGB output enabled. RGB output sync enabled.
0x30	0x1C	625p @ 50 Hz. EAV/SAV synchronization. EIA-770.2 output levels.
0x31	0x01	Pixel data valid.

Table 97. 16-Bit 625p YCrCb In, RGB Out

Subaddress	Setting	Description
0x17	0x02	Software reset.
0x00	0x1C	All DACs enabled. PLL enabled (8x).
0x01	0x10	ED-SDR input mode.
0x02	0x10	RGB output enabled. RGB output sync enabled.
0x30	0x18	625p @ 50 Hz. HSYNC/VSynch synchronization. EIA-770.2 output levels.
0x31	0x01	Pixel data valid.

Table 98. 8-Bit 525p YCrCb In (EAV/SAV), YPrPb Out

Subaddress	Setting	Description
0x17	0x02	Software reset.
0x00	0x1C	All DACs enabled. PLL enabled (8x).
0x01	0x20	ED-DDR input mode. Luma data clocked on falling edge of CLKIN.
0x30	0x04	525p @ 59.94 Hz. EAV/SAV synchronization. EIA-770.2 output levels.
0x31	0x01	Pixel data valid.

Table 99. 10-Bit 525p YCrCb In (EAV/SAV), YPrPb Out

Subaddress	Setting	Description
0x17	0x02	Software reset.
0x00	0x1C	All DACs enabled. PLL enabled (8x).
0x01	0x20	ED-DDR input mode. Luma data clocked on falling edge of CLKIN.
0x30	0x04	525p @ 59.94 Hz. EAV/SAV synchronization. EIA-770.2 output levels.
0x31	0x01	Pixel data valid.
0x33	0x6C	10-bit input enabled.

Table 100. 8-Bit 525p YCrCb In (EAV/SAV), RGB Out

Subaddress	Setting	Description
0x17	0x02	Software reset.
0x00	0x1C	All DACs enabled. PLL enabled (8x).
0x01	0x20	ED-DDR input mode. Luma data clocked on falling edge of CLKIN.
0x02	0x10	RGB output enabled. RGB output sync enabled.
0x30	0x04	525p @ 59.94 Hz. EAV/SAV synchronization. EIA-770.2 output levels.
0x31	0x01	Pixel data valid.

Table 101. 10-Bit 525p YCrCb In (EAV/SAV), RGB Out

Subaddress	Setting	Description
0x17	0x02	Software reset.
0x00	0x1C	All DACs enabled. PLL enabled (8x).
0x01	0x20	ED-DDR input mode. Luma data clocked on falling edge of CLKIN.
0x02	0x10	RGB output enabled. RGB output sync enabled.
0x30	0x04	525p @ 59.94 Hz. EAV/SAV synchronization. EIA-770.2 output levels.
0x31	0x01	Pixel data valid.
0x33	0x6C	10-bit input enabled.

Table 102. 8-Bit 625p YCrCb In (EAV/SAV), YPrPb Out

Subaddress	Setting	Description
0x17	0x02	Software reset.
0x00	0x1C	All DACs enabled. PLL enabled (8x).
0x01	0x20	ED-DDR input mode. Luma data clocked on falling edge of CLKIN.
0x30	0x1C	625p @ 50 Hz. EAV/SAV synchronization. EIA-770.2 output levels.
0x31	0x01	Pixel data valid.

Table 103. 10-Bit 625p YCrCb In (EAV/SAV), YPrPb Out

Subaddress	Setting	Description
0x17	0x02	Software reset.
0x00	0x1C	All DACs enabled. PLL enabled (8x).
0x01	0x20	ED-DDR input mode. Luma data clocked on falling edge of CLKIN.
0x30	0x1C	625p @ 50 Hz. EAV/SAV synchronization. EIA-770.2 output levels.
0x31	0x01	Pixel data valid.
0x33	0x6C	10-bit input enabled.

ADV7390/ADV7391/ADV7392/ADV7393

Table 104. 8-Bit 625p YCrCb In (EAV/SAV), RGB Out

Subaddress	Setting	Description
0x17	0x02	Software reset.
0x00	0x1C	All DACs enabled. PLL enabled (8x).
0x01	0x20	ED-DDR input mode. Luma data clocked on falling edge of CLKIN.
0x02	0x10	RGB output enabled. RGB output sync enabled.
0x30	0x1C	625p @ 50 Hz. EAV/SAV synchronization. EIA-770.2 output levels.
0x31	0x01	Pixel data valid.

Table 105. 10-Bit 625p YCrCb In (EAV/SAV), RGB Out

Subaddress	Setting	Description
0x17	0x02	Software reset.
0x00	0x1C	All DACs enabled. PLL enabled (8x).
0x01	0x20	ED-DDR input mode. Luma data clocked on falling edge of CLKIN.
0x02	0x10	RGB output enabled. RGB output sync enabled.
0x30	0x1C	625p @ 50 Hz. EAV/SAV synchronization. EIA-770.2 output levels.
0x31	0x01	Pixel data valid.
0x33	0x6C	10-bit input enabled.

HIGH DEFINITION

Table 106. HD Configuration Scripts

Input Format	Input Data Width	Synchronization Format	Input Color Space	Output Color Space	Table Number
720p	8-Bit DDR	EAV/SAV	YCrCb	YPrPb	Table 115
720p	8-Bit DDR	EAV/SAV	YCrCb	RGB	Table 117
720p	10-Bit DDR	EAV/SAV	YCrCb	YPrPb	Table 116
720p	10-Bit DDR	EAV/SAV	YCrCb	RGB	Table 118
720p	16-Bit SDR	EAV/SAV	YCrCb	YPrPb	Table 107
720p	16-Bit SDR	HSYNC/VSYNC	YCrCb	YPrPb	Table 108
720p	16-Bit SDR	EAV/SAV	YCrCb	RGB	Table 109
720p	16-Bit SDR	HSYNC/VSYNC	YCrCb	RGB	Table 110
1080i	8-Bit DDR	EAV/SAV	YCrCb	YPrPb	Table 119
1080i	8-Bit DDR	EAV/SAV	YCrCb	RGB	Table 121
1080i	10-Bit DDR	EAV/SAV	YCrCb	YPrPb	Table 120
1080i	10-Bit DDR	EAV/SAV	YCrCb	RGB	Table 122
1080i	16-Bit SDR	EAV/SAV	YCrCb	YPrPb	Table 111
1080i	16-Bit SDR	HSYNC/VSYNC	YCrCb	YPrPb	Table 112
1080i	16-Bit SDR	EAV/SAV	YCrCb	RGB	Table 113
1080i	16-Bit SDR	HSYNC/VSYNC	YCrCb	RGB	Table 114

Table 107. 16-Bit 720p YCrCb In (EAV/SAV), YPrPb Out

Subaddress	Setting	Description
0x17	0x02	Software reset.
0x00	0x1C	All DACs enabled. PLL enabled (4x).
0x01	0x10	HD-SDR input mode.
0x30	0x2C	720p @ 60 Hz/59.94 Hz. EAV/SAV synchronization. EIA-770.3 output levels.
0x31	0x01	Pixel data valid. 4x oversampling.

Table 108. 16-Bit 720p YCrCb In, YPrPb Out

Subaddress	Setting	Description
0x17	0x02	Software reset.
0x00	0x1C	All DACs enabled. PLL enabled (4x).
0x01	0x10	HD-SDR input mode.
0x30	0x28	720p @ 60 Hz/59.94 Hz. HSYNC/VSYNC synchronization. EIA-770.3 output levels.
0x31	0x01	Pixel data valid. 4x oversampling.

Table 109. 16-Bit 720p YCrCb In (EAV/SAV), RGB Out

Subaddress	Setting	Description
0x17	0x02	Software reset.
0x00	0x1C	All DACs enabled. PLL enabled (4x).
0x01	0x10	HD-SDR input mode.
0x02	0x10	RGB output enabled. RGB output sync enabled.
0x30	0x2C	720p @ 60 Hz/59.94 Hz. EAV/SAV synchronization. EIA-770.3 output levels.
0x31	0x01	Pixel data valid. 4x oversampling.

Table 110. 16-Bit 720p YCrCb In, RGB Out

Subaddress	Setting	Description
0x17	0x02	Software reset.
0x00	0x1C	All DACs enabled. PLL enabled (4x).
0x01	0x10	HD-SDR input mode.
0x02	0x10	RGB output enabled. RGB output sync enabled.
0x30	0x28	720p @ 60 Hz/59.94 Hz. HSYNC/VSYNC synchronization. EIA-770.3 output levels.
0x31	0x01	Pixel data valid. 4x oversampling.

Table 111. 16-Bit 1080i YCrCb In (EAV/SAV), YPrPb Out

Subaddress	Setting	Description
0x17	0x02	Software reset.
0x00	0x1C	All DACs enabled. PLL enabled (4x).
0x01	0x10	HD-SDR input mode.
0x30	0x6C	1080i @ 30 Hz/29.97 Hz. EAV/SAV synchronization. EIA-770.3 output levels.
0x31	0x01	Pixel data valid. 4x oversampling.

Table 112. 16-Bit 1080i YCrCb In, YPrPb Out

Subaddress	Setting	Description
0x17	0x02	Software reset.
0x00	0x1C	All DACs enabled. PLL enabled (4x).
0x01	0x10	HD-SDR input mode.
0x30	0x18	1080i @ 30 Hz/29.97 Hz. HSYNC/VSYNC synchronization. EIA-770.3 output levels.
0x31	0x01	Pixel data valid. 4x oversampling.

Table 113. 16-Bit 1080i YCrCb In (EAV/SAV), RGB Out

Subaddress	Setting	Description
0x17	0x02	Software reset.
0x00	0x1C	All DACs enabled. PLL enabled (4x).
0x01	0x10	HD-SDR input mode.
0x02	0x10	RGB output enabled. RGB output sync enabled.
0x30	0x6C	1080i @ 30 Hz/29.97 Hz. EAV/SAV synchronization. EIA-770.3 output levels.
0x31	0x01	Pixel data valid. 4x oversampling.

Table 114. 16-Bit 1080i YCrCb In, RGB Out

Subaddress	Setting	Description
0x17	0x02	Software reset.
0x00	0x1C	All DACs enabled. PLL enabled (4x).
0x01	0x10	HD-SDR input mode.
0x02	0x10	RGB output enabled. RGB output sync enabled.
0x30	0x18	1080i @ 30 Hz/29.97 Hz. HSYNC/VSYNC synchronization. EIA-770.3 output levels.
0x31	0x01	Pixel data valid. 4x oversampling.

Table 115. 8-Bit 720p YCrCb In (EAV/SAV), YPrPb Out

Subaddress	Setting	Description
0x17	0x02	Software reset.
0x00	0x1C	All DACs enabled. PLL enabled (4x).
0x01	0x20	HD-DDR input mode. Luma data clocked on falling edge of CLKIN.
0x30	0x2C	720p @ 60 Hz/59.94 Hz. EAV/SAV synchronization. EIA-770.3 output levels.
0x31	0x01	Pixel data valid. 4x oversampling.

Table 116. 10-Bit 720p YCrCb In (EAV/SAV), YPrPb Out

Subaddress	Setting	Description
0x17	0x02	Software reset.
0x00	0x1C	All DACs enabled. PLL enabled (4x).
0x01	0x20	HD-DDR input mode. Luma data clocked on falling edge of CLKIN.
0x30	0x2C	720p @ 60 Hz/59.94 Hz. EAV/SAV synchronization. EIA-770.3 output levels.
0x31	0x01	Pixel data valid. 4x oversampling.
0x33	0x6C	10-bit input enabled.

ADV7390/ADV7391/ADV7392/ADV7393

Table 117. 8-Bit 720p YCrCb In (EAV/SAV), RGB Out

Subaddress	Setting	Description
0x17	0x02	Software reset.
0x00	0x1C	All DACs enabled. PLL enabled (4x).
0x01	0x20	HD-DDR input mode. Luma data clocked on falling edge of CLKIN.
0x02	0x10	RGB output enabled. RGB output sync enabled.
0x30	0x2C	720p @ 60 Hz/59.94 Hz. EAV/SAV synchronization. EIA-770.3 output levels.
0x31	0x01	Pixel data valid. 4x oversampling.

Table 118. 10-Bit 720p YCrCb In (EAV/SAV), RGB Out

Subaddress	Setting	Description
0x17	0x02	Software reset.
0x00	0x1C	All DACs enabled. PLL enabled (4x).
0x01	0x20	HD-DDR input mode. Luma data clocked on falling edge of CLKIN.
0x02	0x10	RGB output enabled. RGB output sync enabled.
0x30	0x2C	720p @ 60 Hz/59.94 Hz. EAV/SAV synchronization. EIA-770.3 output levels.
0x31	0x01	Pixel data valid. 4x oversampling.
0x33	0x6C	10-bit input enabled.

Table 119. 8-Bit 1080i YCrCb In (EAV/SAV), YPrPb Out

Subaddress	Setting	Description
0x17	0x02	Software reset.
0x00	0x1C	All DACs enabled. PLL enabled (4x).
0x01	0x20	HD-DDR input mode. Luma data clocked on falling edge of CLKIN.
0x30	0x6C	1080i @ 30 Hz/29.97 Hz. EAV/SAV synchronization. EIA-770.3 output levels.
0x31	0x01	Pixel data valid. 4x oversampling.

Table 120. 10-Bit 1080i YCrCb In (EAV/SAV), YPrPb Out

Subaddress	Setting	Description
0x17	0x02	Software reset.
0x00	0x1C	All DACs enabled. PLL enabled (4x).
0x01	0x20	HD-DDR input mode. Luma data clocked on falling edge of CLKIN.
0x30	0x6C	1080i @ 30 Hz/29.97 Hz. EAV/SAV synchronization. EIA-770.3 output levels.
0x31	0x01	Pixel data valid. 4x oversampling.
0x33	0x6C	10-bit input enabled.

Table 121. 8-Bit 1080i YCrCb In (EAV/SAV), RGB Out

Subaddress	Setting	Description
0x17	0x02	Software reset.
0x00	0x1C	All DACs enabled. PLL enabled (4x).
0x01	0x20	HD-DDR input mode. Luma data clocked on falling edge of CLKIN.
0x02	0x10	RGB output enabled. RGB output sync enabled.
0x30	0x6C	1080i @ 30 Hz/29.97 Hz. EAV/SAV synchronization. EIA-770.3 output levels.
0x31	0x01	Pixel data valid. 4x oversampling.

Table 122. 10-Bit 1080i YCrCb In (EAV/SAV), RGB Out

Subaddress	Setting	Description
0x17	0x02	Software reset.
0x00	0x1C	All DACs enabled. PLL enabled (4x).
0x01	0x20	HD-DDR input mode. Luma data clocked on falling edge of CLKIN.
0x02	0x10	RGB output enabled. RGB output sync enabled.
0x30	0x6C	1080i @ 30 Hz/29.97 Hz. EAV/SAV synchronization. EIA-770.3 output levels.
0x31	0x01	Pixel data valid. 4x oversampling.
0x33	0x6C	10-bit input enabled.

OUTLINE DIMENSIONS

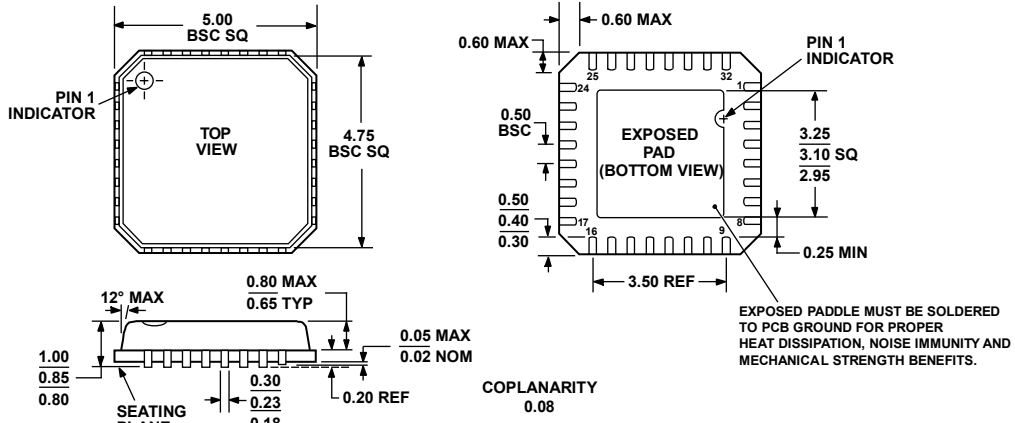

Figure 142. 32-Lead Lead Frame Chip Scale Package [LFCSP_VQ]
5 mm × 5 mm Body, Very Thin Quad
(CP-32-2)
Dimensions shown in millimeters

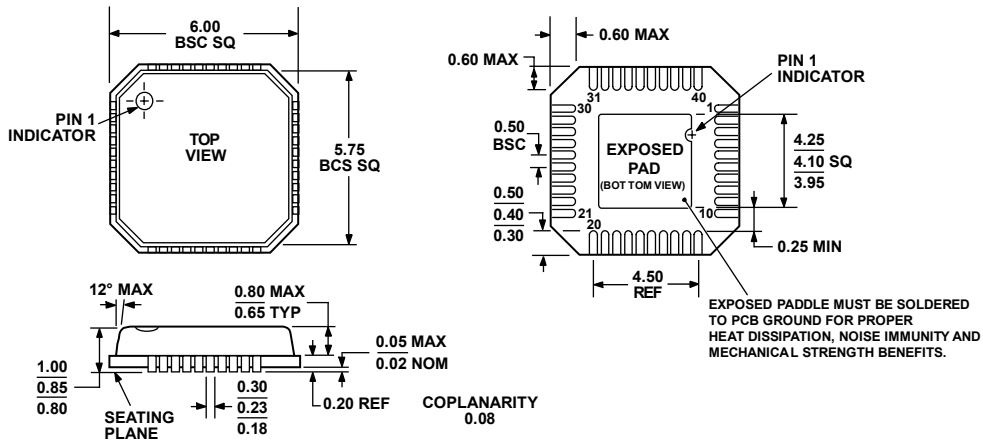

Figure 143. 40-Lead Frame Chip Scale Package [LFCSP]
(CP-40)
Dimensions shown in millimeters

ADV7390/ADV7391/ADV7392/ADV7393

ORDERING GUIDE

Model	Temperature Range	Macrovision ¹ Anti-Taping	Package Description	Package Option
ADV7390BCPZ ²	-40°C to +85°C	Yes	32-Lead Lead Frame Chip Scale Package [LFCSP_VQ]	CP-32-2
ADV7390BCPZ-REEL ²	-40°C to +85°C	Yes	32-Lead Lead Frame Chip Scale Package [LFCSP_VQ]	CP-32-2
ADV7391BCPZ ²	-40°C to +85°C	No	32-Lead Lead Frame Chip Scale Package [LFCSP_VQ]	CP-32-2
ADV7391BCPZ-REEL ²	-40°C to +85°C	No	32-Lead Lead Frame Chip Scale Package [LFCSP_VQ]	CP-32-2
ADV7392BCPZ ²	-40°C to +85°C	Yes	40-Lead Lead Frame Chip Scale Package [LFCSP_VQ]	CP-40
ADV7392BCPZ-REEL ²	-40°C to +85°C	Yes	40-Lead Lead Frame Chip Scale Package [LFCSP_VQ]	CP-40
ADV7393BCPZ ²	-40°C to +85°C	No	40-Lead Lead Frame Chip Scale Package [LFCSP_VQ]	CP-40
ADV7393BCPZ-REEL ²	-40°C to +85°C	No	40-Lead Lead Frame Chip Scale Package [LFCSP_VQ]	CP-40
EVAL-ADV739xFEZ ^{2, 3}		N/A	ADV739x Evaluation Platform Front-End Board.	
EVAL-ADV7390EBZ ²		Yes	ADV7390 Evaluation Board	
EVAL-ADV7391EBZ ²		No	ADV7391 Evaluation Board	
EVAL-ADV7392EBZ ²		Yes	ADV7392 Evaluation Board	
EVAL-ADV7393EBZ ²		No	ADV7393 Evaluation Board	

¹ Macrovision-enabled ICs require the buyer to be an approved licensee (authorized buyer) of ICs that are able to output Macrovision Rev 7.1.L1-compliant video.

² Z = Pb-free.

³ To be used in conjunction with any one of the ADV793x evaluation boards; this front-end board contains an Analog Devices decoder and Xilinx Spartan-3 FPGA.

Purchase of licensed I²C components of Analog Devices or one of its sublicensed Associated Companies conveys a license for the purchaser under the Philips I²C Patent Rights to use these components in an I²C system, provided that the system conforms to the I²C Standard Specification as defined by Philips.